



ANVISNINGAR FÖR SJÄLVMONTERING AV POOLTAK



INSTRUCTIONS FOR SELF-ASSEMBLY OF THE POOL ENCLOSURE



INSTRUKCJA DO SAMODZIELNEGO MONTAŻU ZADASZENIA

MONTAŻ PROWADNIC / INSTALLATION OF GUIDES / INSTALLATION AV LEDSKENOR

1

PL: Podłoże przed zamontowaniem szyn powinno być wypoziomowane i utwardzone. Rozmieszczenie szyn rozpoczynamy od wewnątrz (wymiar C). Należy dokładnie zwymiarować za pomocą przekątnych.

ENG: The base should be leveled and hardened before mounting the rails. Start arranging the rails from the inside (dimension C). Dimension the diagonals accurately.

SE: Underlaget ska vara jämnt och hårt innan du monterar skenorna. Börja arrangera skenorna från insidan (mått C). Dimensionera diagonalerna noggrant.

2

PL: Szyny mocujemy za pomocą kołków rozporowych z opakowania 16 i 17 co 80cm. Ostatnią listwę wewnętrzną kończymy zaślepką.

ENG: Rails are mounted to expansion bolts from the package 16 and 17, every 80cm. We finish the last inner rail with a blanking plate.

SE: Fäst skenorna med expansionspluggarna från förpackning 16 och 17 med 80 cm mellanrum.

3

PL: W celu przedłużenia długości szyn należy połączyć je specjalnym bolcem nr 18.

ENG: In order to extend the length of rails, they should be connected with a use of a special pin no. 18.

SE: För att förlänga skenorna, koppla ihop dem med den speciella stiftpinnen nr 18.

1

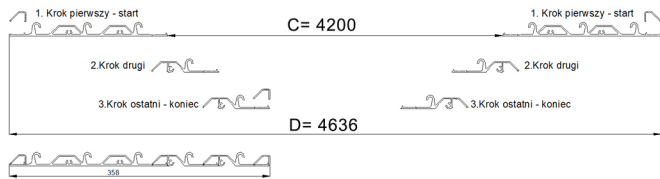
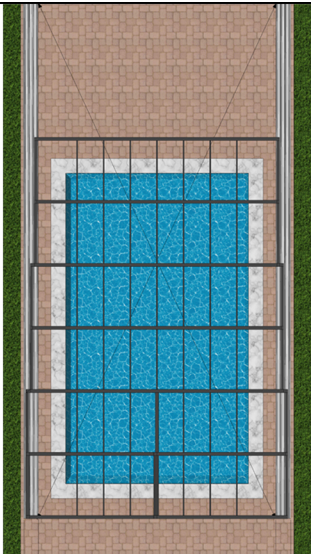

2

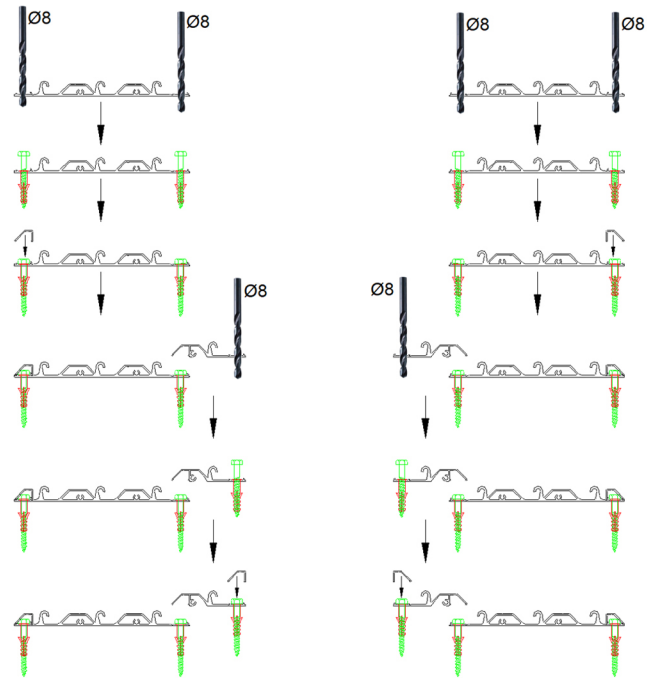

3

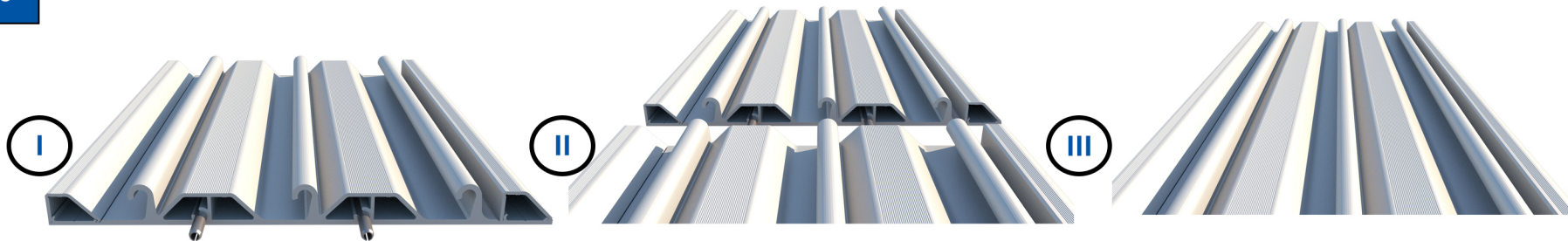

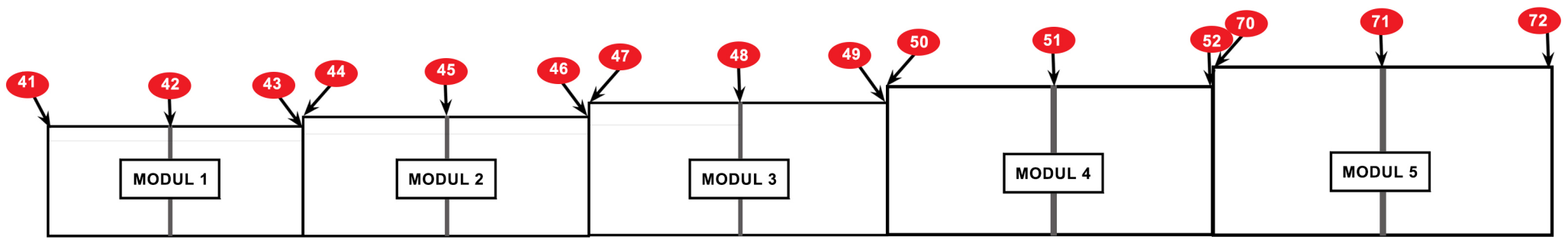
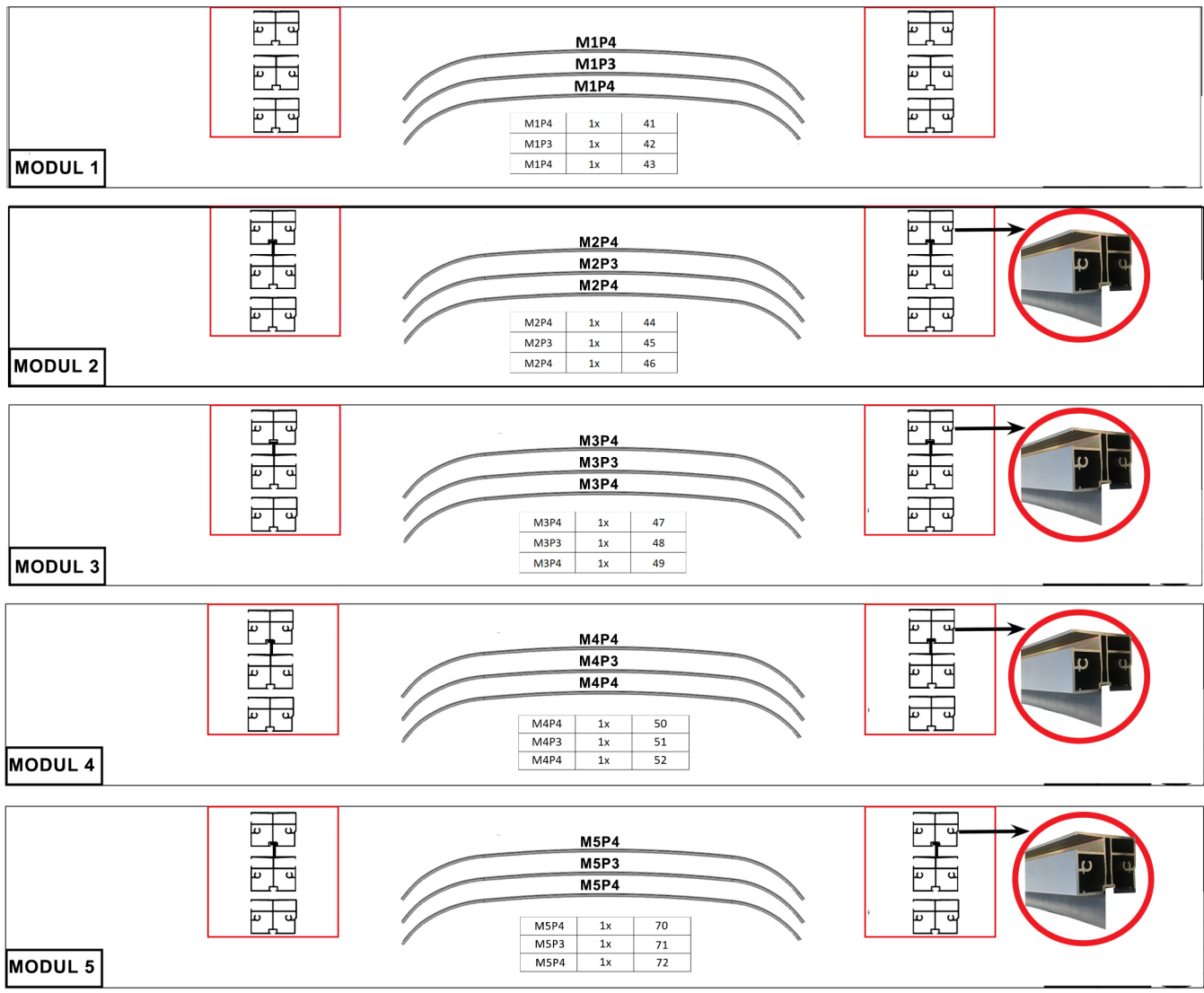

NARZĘDZIA - MODUŁ 1 / TOOLS - MODULE 1 / VERKTYG - MODUL 1

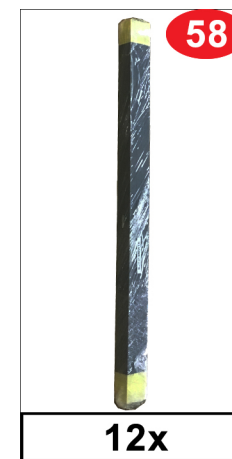
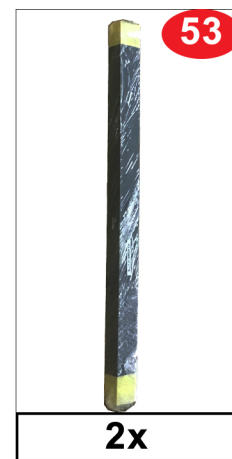
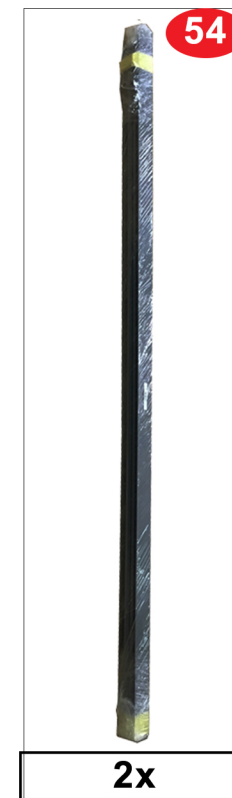
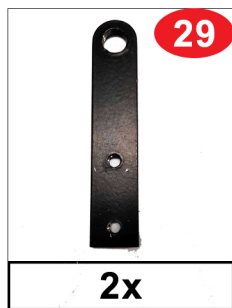
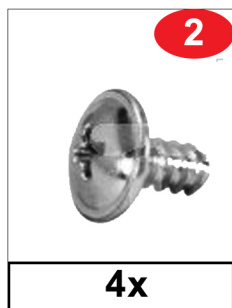



MONTAŻ MODUŁU 1 / INSTALLATION OF MODULE 1 / MONTERING AV MODUL 1

1

PL: Odklejamy 5 cm od każdego brzegu poliwęglanu.
ENG: We have to peel off 5 cm from every edge of polycarbonate.
SE: Avlägsna 5 cm från varje kant av polykarbonat

2

PL: Profil M1P4 (41) nitujemy z profilem 53 nitem z opakowania 20.
ENG: We rivet M1P4 (41) profile with the profile no. 53 using a rivet from package 20.
SE: M1P4 (41)-profilen nitas med 53-profilen med en nit från 20-paketet.

3

PL: W profil M1P4 (41) wkładamy poliwęglan napisami UV po zewnętrznej stronie zadaszenia. Następnie dokładamy i dokręcamy profil M1P1 (54) z zamontowanym wózkim do góry z profilem M1P4 (41) wkrętami z opakowania 1.
ENG: Into M1P4 (41) profile we insert polycarbonate with UV inscription on the exterior side of roofing. Afterwards we add and screw in M1P1 (54) profile with the cart mounted to the top with M1P4 (41) profile with bolts from package 1.
SE: Sätt in polykarbonat i M1P4-profilen (41) med UV-texten på ytersidan av taket. Lägg sedan till och dra åt profil M1P1 (54) med monterad vagn till profil M1P4 (41) med skruvar från förpackning 1

4

PL: M1P3 (42) łączymy z M1P1 (54) za pomocą śrub nr 1 po obu stronach modułu. Wsuwamy następne części poliwęglanu. Profil M1P3 (42) nitujemy z profilem 53 nitem z opakowania 20.
ENG: We connect M1P3 (42) with M1P1 (54) with the use of screws no.1 on both sides of the module. We insert the next parts of polycarbonate. We rivet M1P3 (42) profile with the profile no. 53 using a rivet from package 20.
SE: M1P3 (42) ansluts till M1P1 (54) med skruvarna från paket 1 på båda sidor av modulen. Sätt in den andra delen av polykarbonat. M1P3 (42)-profilen nitas med 53-profilen med en nit från 20-paketet.

5

PL: Cały moduł zamykamy profilem M1P4 (43) łącząc go z M1P1 (54) wkrętami z opakowania 1 po obu stronach. Uszczelniamy cały moduł uszczelkami nr 32 po zewnętrznej stronie.
ENG: We close the entire module with M1P4 (43) profile connecting it with M1P1 (54) using bolts from package 1 on both sides. We seal the entire module with seals no. 32 on the outside.
SE: Stäng hela modulen med profilen M1P4 (43) och anslut den till M1P1 (54) med hjälp av skruvarna från paket 1 på båda sidor. Vi tätar hela modulen med packningar nr 32 på utsidan.

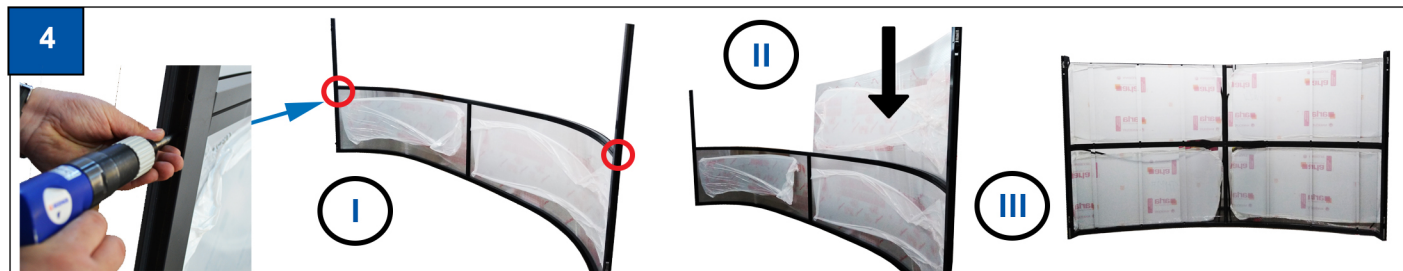
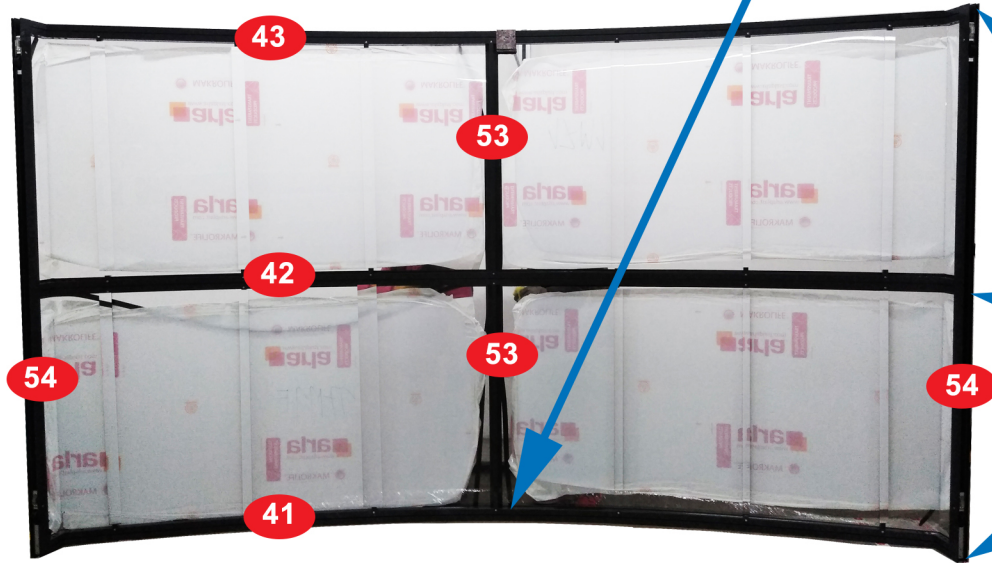
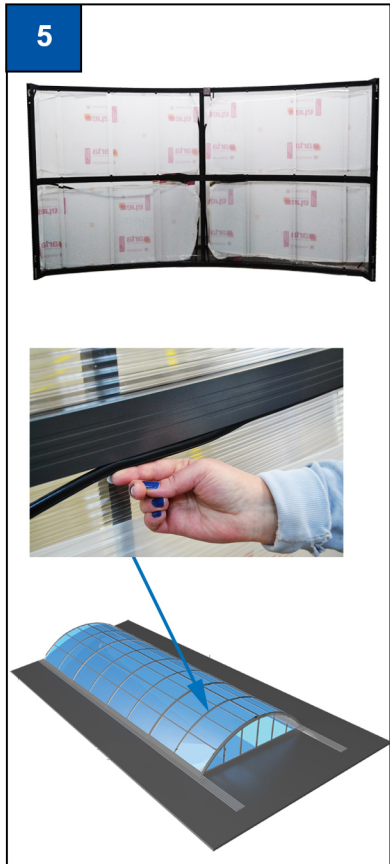
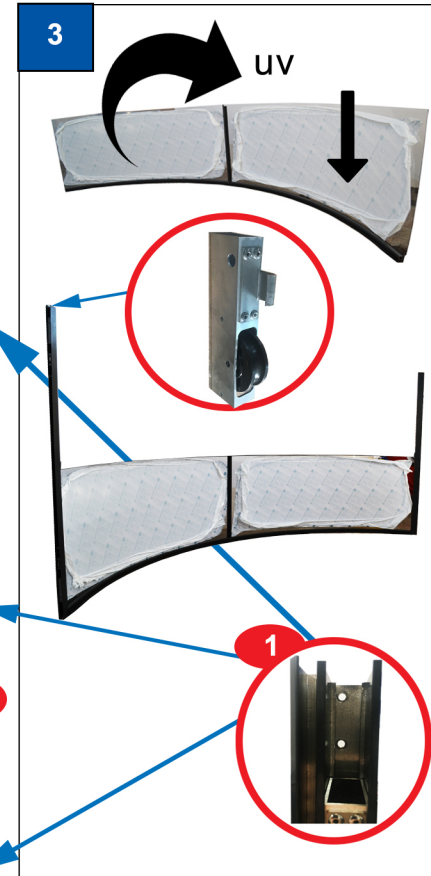
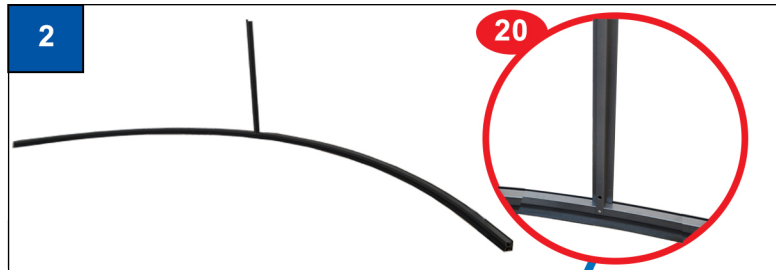
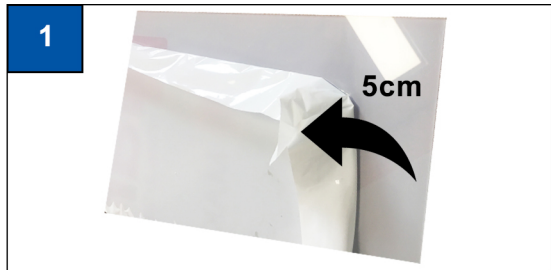



MONTAŻ MODUŁU 1 / INSTALLATION OF MODULE 1 / MONTERING AV MODUL 1

6

PL: Dwanaście łączników 58 montujemy za pomocą nitów z opakowania 20 z profilami 43,42,41.
ENG: We mount twelve connectors 58 with the use of rivets from package 20 with profiles 43,42,41.
SE: Fäst de tolv kopplingarna 58 med hjälp av nitar i paket 20 med profilerna 43,42,41.

7

PL: Hamulce 29 przykręcamy śrubami imbusowymi nr 30 do wózków 65.
ENG: We screw in the brakes 29 with the use of six-lobe screws no. 30 to the carts 65.
SE: Skruva fast bromsarna 29 på boggierna 65 med insexskruvarna 30.

8

PL: Złożony wózek z hamulcem wsuwamy od dołu w profil 54 po prawej i lewej stronie zadaszania, następnie przykręcamy blachowkrętami nr 2.
ENG: We insert the folded carts with the brakes into profiles 54 on the left and right side of roofing from the bottom and we screw it with sheet metal screws no. 2.
SE: Sätt in den monterade vagnen med broms underifrån i profil 54 på takets högra och vänstra sida och skruva fast den med plåtskruvar nr 2.

9

PL: Wkładamy zaślepki w odpowiednie miejsca: od dołu - zaślepki 5 lub 6, od góry - zaślepki 7 lub 8.
ENG: We insert blind plugs in proper places: from the bottom – blind plug 5 or 6, from the top - blind plugs 7 or 8.
SE: Sätt in kapslingarna på rätt plats: kapslingarna 5 eller 6 underifrån, kapslingarna 7 eller 8 ovanifrån.

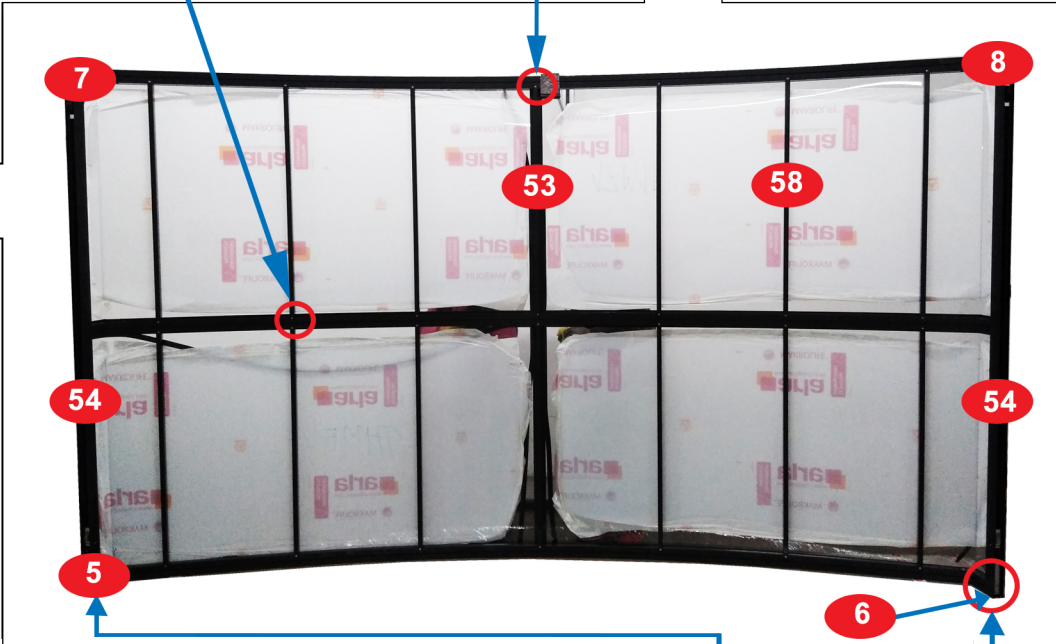
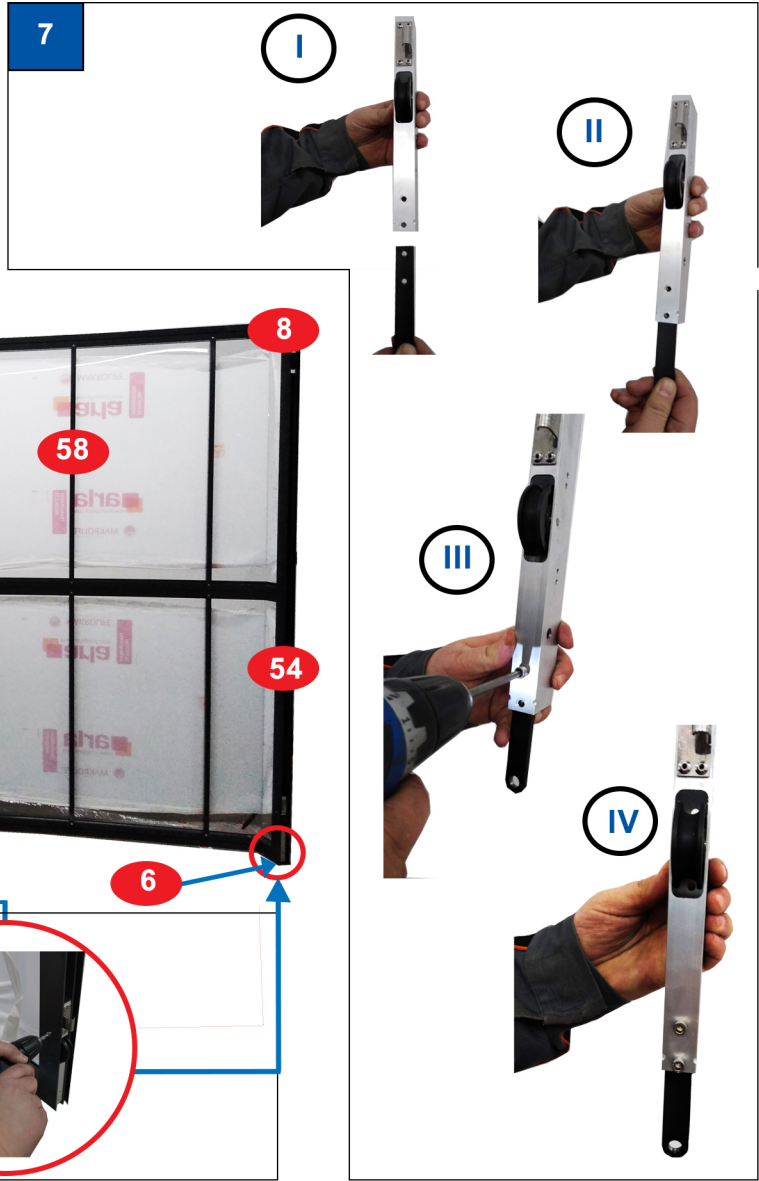
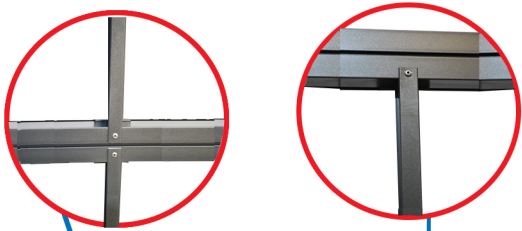

NARZĘDZIA - MODUŁ 2 / TOOLS - MODULE 2 / VERKTYG - MODUL 2

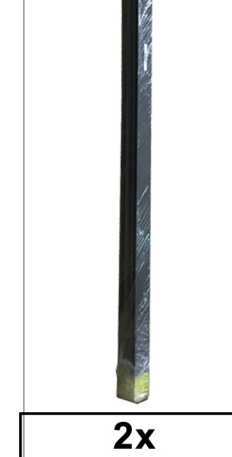
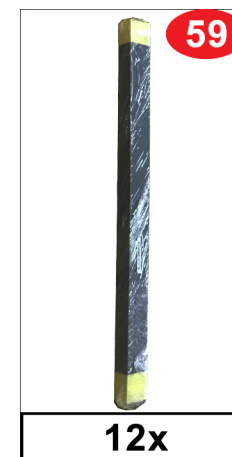
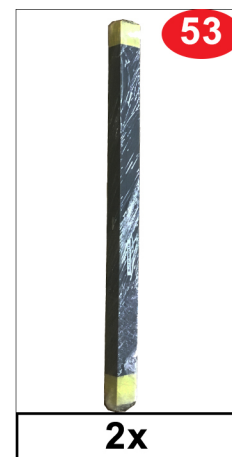
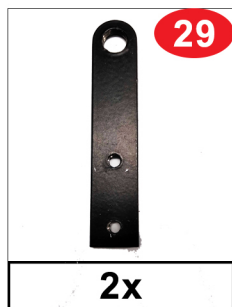



MONTAŻ MODUŁU 2 / INSTALLATION OF MODULE 2 / MONTERING AV MODUL 2

1

PL: Odklejamy 5 cm od każdego brzegu poliwęglanu.
ENG: We have to peel off 5 cm from every edge of polycarbonate.
SE: Avlägsna 5 cm från varje kant av polykarbonat

2

PL: Profil M2P4 (44) nitujemy z profilem 53 nitem z opakowania 20.
ENG: We rivet M2P4 (44) profile with the profile no. 53 using a rivet from package 20.
SE: M2P4 (44)-profilen nitas med 53-profilen med en nit från 20-paketet.

3

PL: W profil M2P4 (44) wkładamy poliwęglan napisami UV po zewnętrznej stronie zadaszenia. Następnie dokładamy i dokręcamy profil M2P1 (55) z zamontowanym wózkem do góry z profilem M2P4 (44) wkrętami z opakowania 1.
ENG: Into M2P4 (44) profile we insert polycarbonate with UV inscription on the exterior side of roofing. Afterwards we add and screw in M2P1 (55) profile with the cart mounted to the top with M2P4 (44) profile with bolts from package 1.
SE: Sätt in polykarbonat i M2P4-profilen (44) med UV-texten på yttersidan av taket. Lägg sedan till och dra åt profil M2P1 (55) med monterad vagn till profil M2P4 (44) med skruvar från förpackning 1

4

PL: M2P3 (45) łączymy z M2P1 (55) za pomocą śrub nr 1 po obu stronach modułu. Wsuwamy następne części poliwęglanu. Profil M2P3 (45) nitujemy z profilem 53 nitem z opakowania 20.
ENG: We connect M2P3 (45) with M2P1 (55) with the use of screws no.1 on both sides of the module. We insert the next parts of polycarbonate. We rivet M2P3 (45) profile with the profile no. 53 using a rivet from package 20.
SE: M2P3 (45) ansluts till M2P1 (55) med skruvarna från paket 1 på båda sidor av modulen. Sätt in den andra delen av polykarbonat. M2P3 (45)-profilen nitas med 53-profilen med en nit från 20-paketet.

5

PL: Cały moduł zamykamy profilem M2P4 (46) łącząc go z M2P1 (55) wkrętami z opakowania 1 po obu stronach. Uszczelniamy cały moduł uszczelkami nr 32 po zewnętrznej stronie.
ENG: We close the entire module with M2P4 (46) profile connecting it with M2P1 (55) using bolts from package 1 on both sides. We seal the entire module with seals no. 32 on the outside.
SE: Stäng hela modulen med profilen M2P4 (46) och anslut den till M2P1 (55) med hjälp av skruvarna från paket 1 på båda sidor. Vi tätar hela modulen med packningar nr 32 på utsidan.

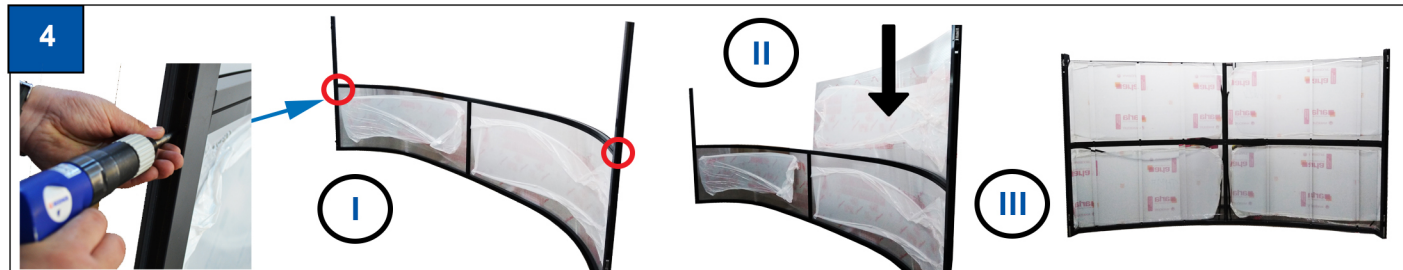
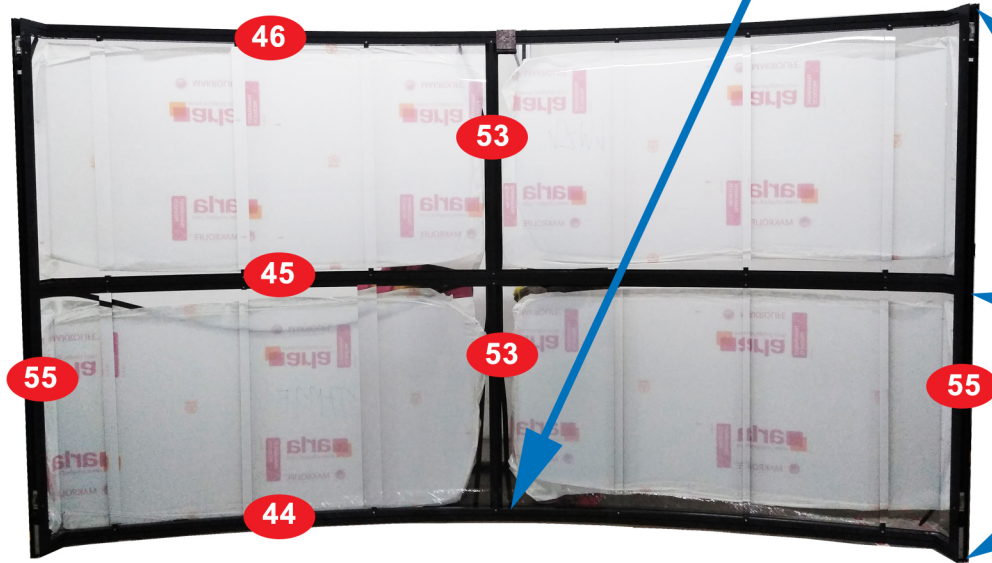
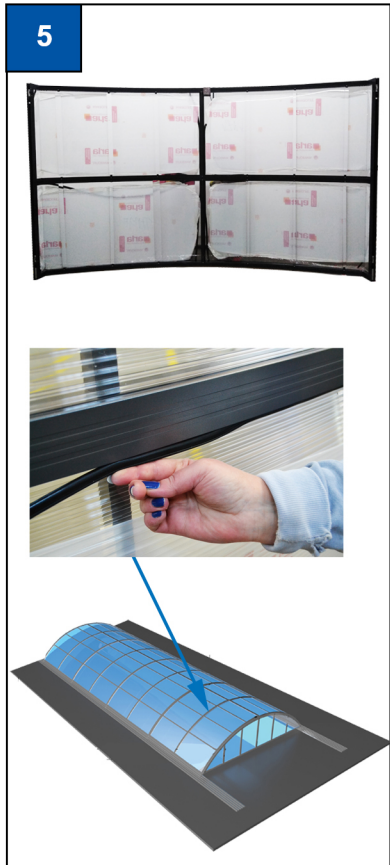
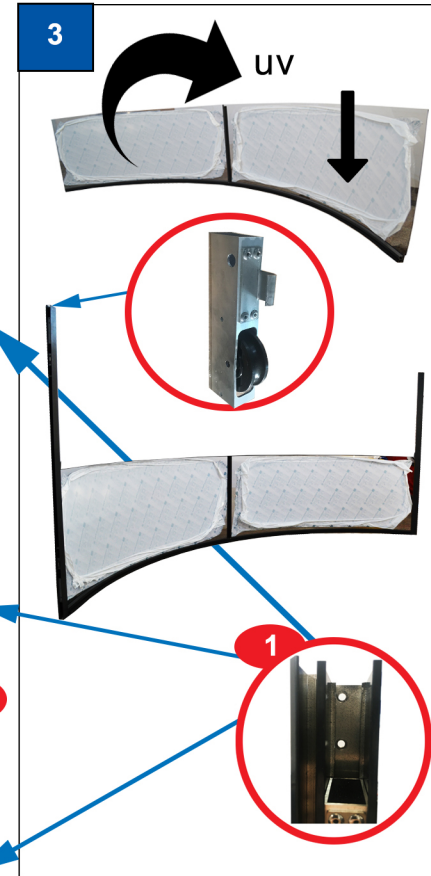
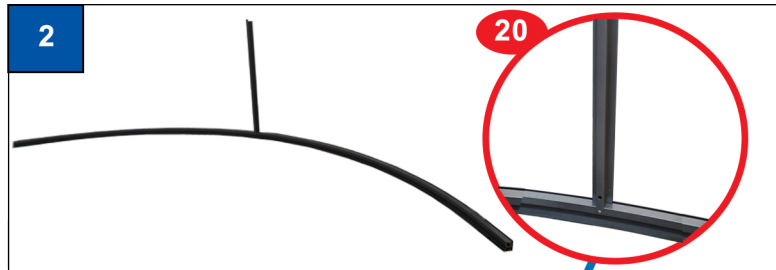
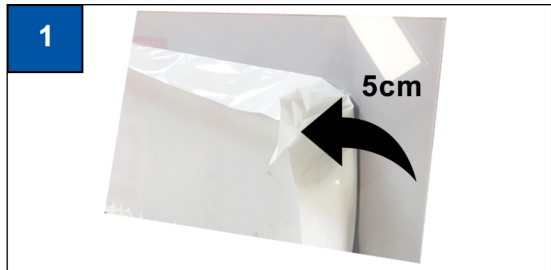



MONTAŻ MODUŁU 2 / INSTALLATION OF MODULE 2 / MONTERING AV MODUL 2

6

PL: Dwanaście łączników 59 montujemy za pomocą nitów z opakowania 20 z profilami 46, 45, 44.

ENG: We mount twelve connectors 59 with the use of rivets from package 20 with profiles 46, 45, 44.

SE: Fäst de tolv kopplingarna 59 med hjälp av nitar i paket 20 med profilerna 46, 45, 44

7

PL: Hamulce 29 przykręcamy śrubami imbusowymi nr 30 do wózków 65.

ENG: We screw in the brakes 29 with the use of six-lobe screws no. 30 to the carts 65.

SE: Skruva fast bromsarna 29 på boggierna 65 med insexskruvarna 30.

8

PL: Złożony wózek z hamulcem wsuwamy od dołu w profil 55 po prawej i lewej stronie zadaszania, następnie przykręcamy blachowkrętami nr 2.

ENG: We insert the folded carts with the brakes into profiles 55 on the left and right side of roofing from the bottom and we screw it with sheet metal screws no. 2.

SE: Sätt in den monterade vagnen med broms underifrån i profil 55 på takets högra och vänstra sida och skruva fast den med plåtskruvar nr 2.

9

PL: Wkładamy zaślepki w odpowiednie miejsca: od dołu - zaślepki 5 lub 6, od góry - zaślepki 7 lub 8.

ENG: We insert blind plugs in proper places: from the bottom – blind plug 5 or 6, from the top - blind plugs 7 or 8.

SE: Sätt in kapslingarna på rätt plats: kapslingarna 5 eller 6 underifrån, kapslingarna 7 eller 8 ovanifrån.

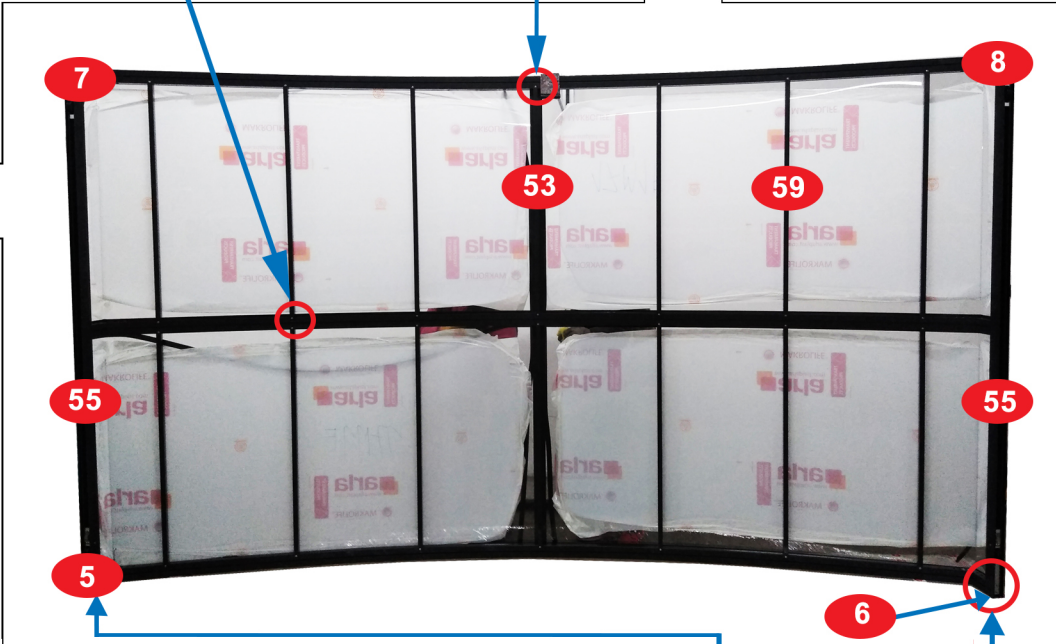
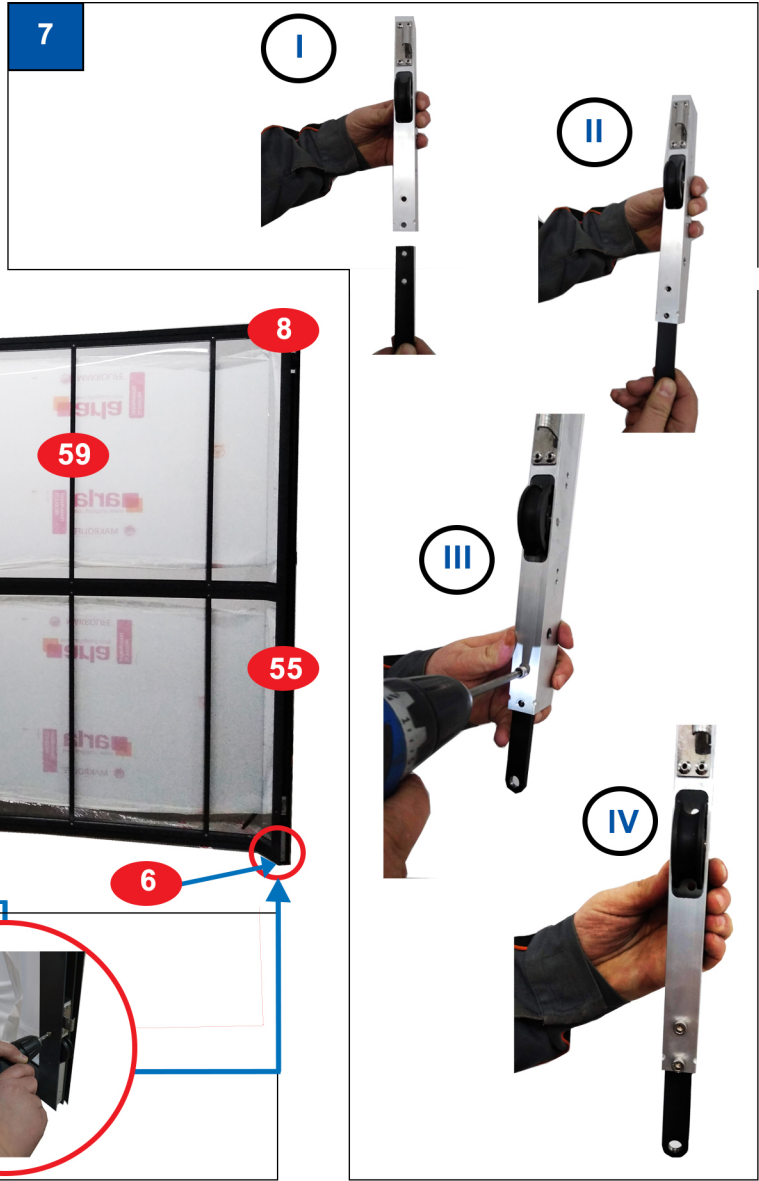
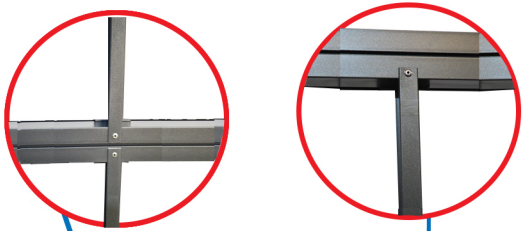

NARZĘDZIA - MODUŁ 3 / TOOLS - MODULE 3 / VERKTYG - MODUL 3

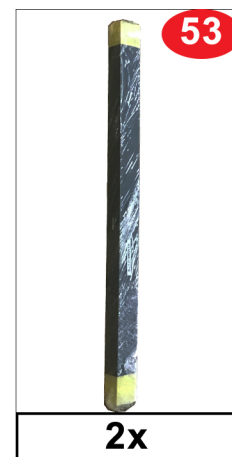

MONTAŻ MODUŁU 3 / INSTALLATION OF MODULE 3 / MONTAGE DES MODULS 3



1

PL: Odklejamy 5 cm od każdego brzegu poliwęglanu.
ENG: We have to peel off 5 cm from every edge of polycarbonate.
SE: Avlägsna 5 cm från varje kant av polykarbonat

2

PL: Profil M3P4 (47) nitujemy z profilem 53 nitem z opakowania 20.
ENG: We rivet M3P4 (47) profile with the profile no. 53 using a rivet from package 20.
SE: M3P4 (47)-profilen nitas med 53-profilen med en nit från 20-paketet.

3

PL: W profil M3P4 (47) wkładamy poliwęglan napisami UV po zewnętrznej stronie zadaszenia. Następnie dokładamy i dokręcamy profil M3P1 (56) z zamontowanym wózkiem do góry z profilem M3P4 (47) wkrętami z opakowania 1.
ENG: Into M3P4 (47) profile we insert polycarbonate with UV inscription on the exterior side of roofing. Afterwards we add and screw in M3P1 (56) profile with the cart mounted to the top with M3P4 (47) profile with bolts from package 1.
SE: Sätt in polykarbonat i M3P4-profilen (47) med UV-texten på ytersidan av taket. Lägg sedan till och dra åt profil M3P1 (56) med monterad vagn till profil M3P4 (47) med skruvar från förpackning 1

4

PL: M3P3 (48) łączymy z M3P1 (56) za pomocą śrub nr 1 po obu stronach modułu. Wsuwamy następne części poliwęglanu. Profil M3P3 (48) nitujemy z profilem 53 nitem z opakowania 20.
ENG: We connect M3P3 (48) with M3P1 (56) with the use of screws no.1 on both sides of the module. We insert the next parts of polycarbonate. We rivet M3P3 (48) profile with the profile no. 53 using a rivet from package 20.
SE: M3P3 (48) ansluts till M3P1 (56) med skruvarna från paket 1 på båda sidor av modulen. Sätt i den andra delen av polykarbonatet. M3P3 (48)-profilen nitas med 53-profilen med en nit från 20-paketet.

5

PL: Cały moduł zamykamy profilem M3P4 (49) łącząc go z M3P1 (56) wkrętami z opakowania 1 po obu stronach. Uszczelniamy cały moduł uszczelkami nr 32 po zewnętrznej stronie.
ENG: We close the entire module with M3P4 (49) profile connecting it with M3P1 (56) using bolts from package 1 on both sides. We seal the entire module with seals no. 32 on the outside.
SE: Stäng hela modulen med profilen M3P4 (49) och anslut den till M3P1 (56) med hjälp av skruvarna från paket 1 på båda sidor. Vi tätar hela modulen med packningar nr 32 på utsidan.

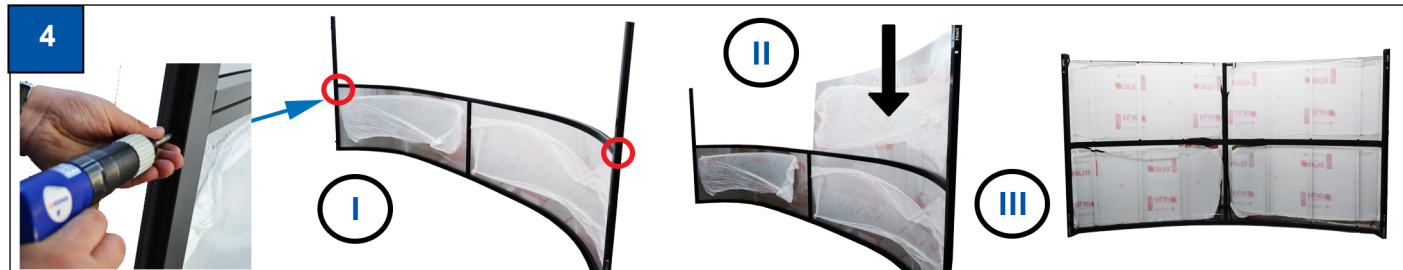
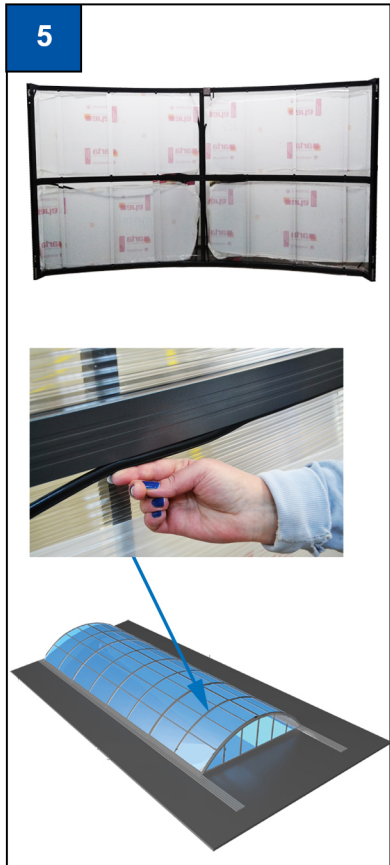
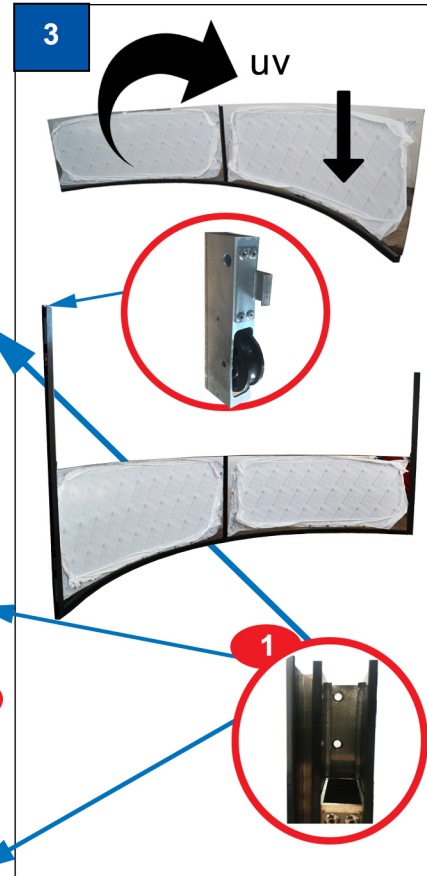
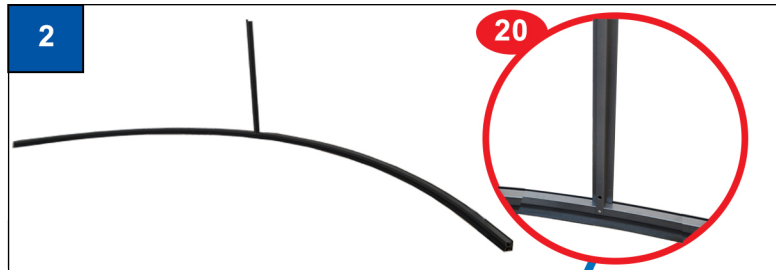
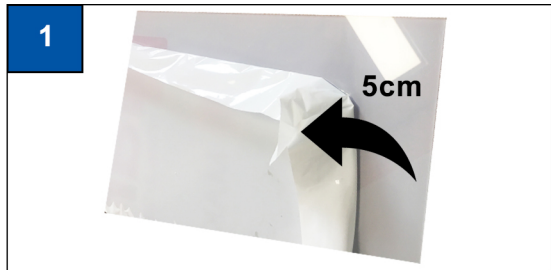



MONTAŻ MODUŁU 3 / INSTALLATION OF MODULE 3 / MONTERING AV MODUL 3

6

PL: Dwanaście łączników 60 montujemy za pomocą nitów z opakowania 20 z profilami 49,48,47.

ENG: We fasten twelve connectors no. 60 with the use of rivets from package 20 using profiles 49,48,47.

SE: Fäst de tolv kopplingarna 60 med hjälp av nitar i paket 20 med profilerna 49,48,47.

7

PL: Hamulce 29 przykręcamy śrubami imbusowymi nr 30 do wózków 65.

ENG: We screw in the brakes 29 with the use of six-lobe screws no. 30 to the carts 65.

SE: Skruva fast bromsarna 29 på boggierna 65 med insexskruvarna 30.

8

PL: Złożony wózek z hamulcem wsuwamy od dołu w profil 56 po prawej i lewej stronie zadaszania, następnie przykręcamy blachowkrętami nr 2.

ENG: We insert the folded carts with the brakes into profiles 56 on the left and right side of roofing from the bottom and we screw it with sheet metal screws no. 2.

SE: Sätt in den monterade vagnen med broms underifrån i profil 56 på takets högra och vänstra sida och skruva fast den med plåtskruvar nr 2.

9

PL: Wkładamy zaślepki w odpowiednie miejsca: od dołu - zaślepki 5 lub 6, od góry - zaślepki 7 lub 8.

ENG: We insert blind plugs in proper places: from the bottom – blind plug 5 or 6, from the top - blind plugs 7 or 8.

SE: Sätt in kapslingarna på rätt plats: kapslingarna 5 eller 6 underifrån, kapslingarna 7 eller 8 ovanifrån.

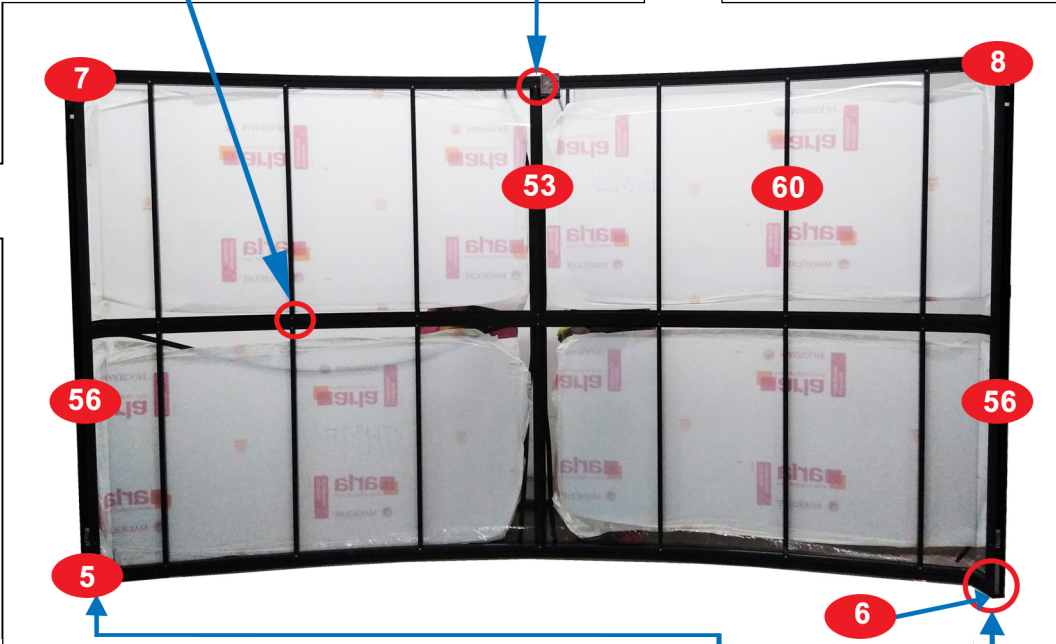
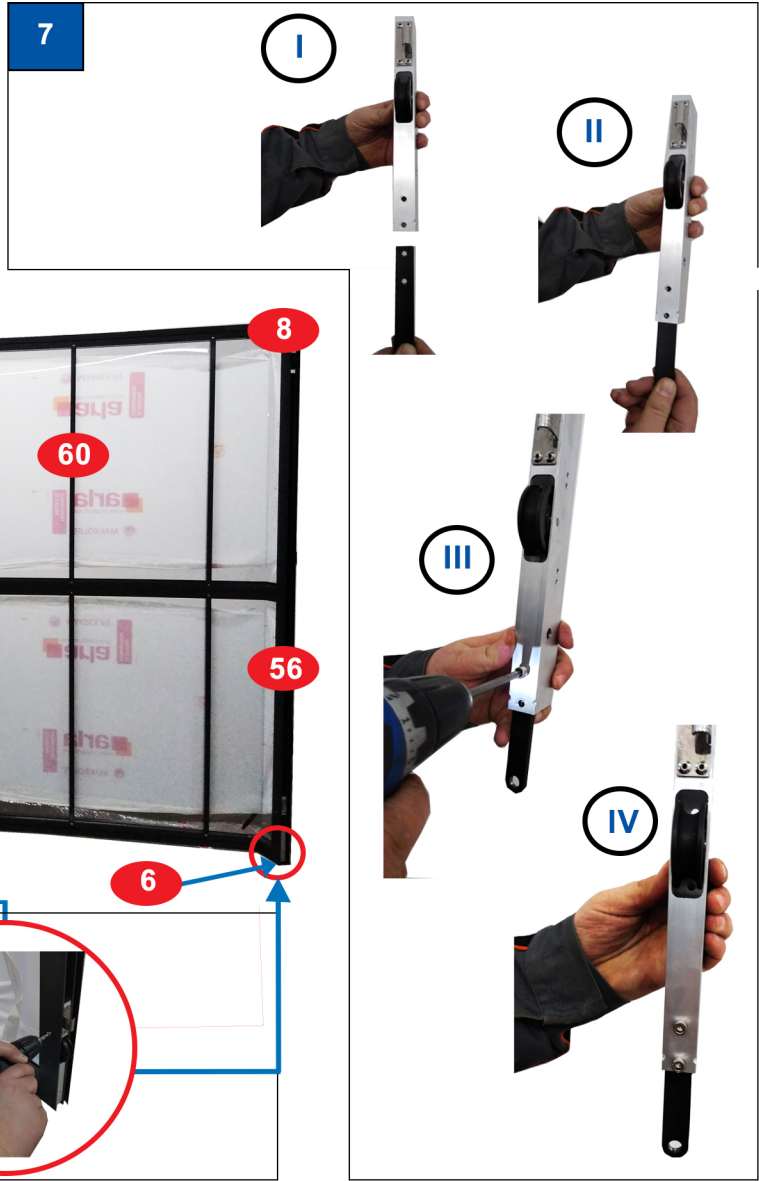
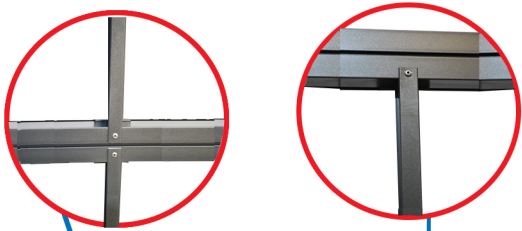

NARZĘDZIA - MODUŁ 4 / TOOLS - MODULE 4 / VERKTYG - MODUL 4

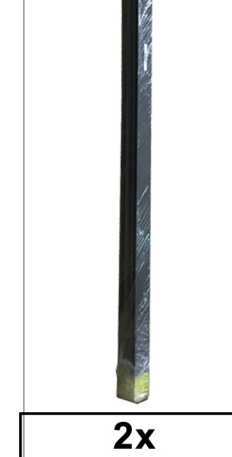
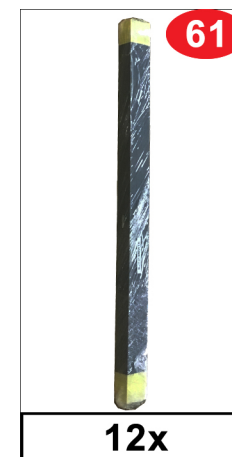
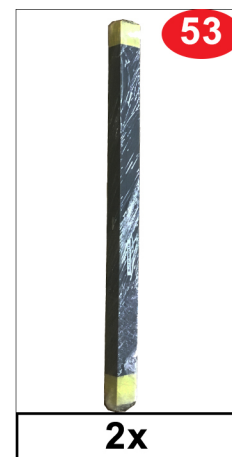

MONTAŻ MODUŁU 4 / INSTALLATION OF MODULE 4 / MONTAGE DES MODULS 4



1

PL: Odklejamy 5 cm od każdego brzegu poliwęglanu.
ENG: We have to peel off 5 cm from every edge of polycarbonate.
SE: Avlägsna 5 cm från varje kant av polykarbonat

2

PL: Profil M4P4 (50) nitujemy z profilem 53 nitem z opakowania 20.
ENG: We rivet M4P4 (50) profile with the profile no. 53 using a rivet from package 20.
DE: Das M4P4-Profil (50) ist mit dem Profil Nr. 53 mit Hilfe des Nietes von der Packung Nr. 20 zu nieten.

3

PL: W profil M4P4 (50) wkładamy poliwęglan napisami UV po zewnętrznej stronie zadaszania. Następnie dokładamy i dokręcamy profil M4P1 (57) z zamontowanym wózkem do góry z profilem M4P4 (50) wkrętami z opakowania 1.
ENG: Into M4P4 (50) profile we insert polycarbonate with UV inscription on the exterior side of roofing. Afterwards we add and screw in M4P1 (57) profile with the cart mounted to the top with M4P4 (50) profile with bolts from package 1.
DE: Im M4P4-Profil (50) ist der Polycarbonat-Teil mit den UV-Aufschriften an der Außenseite der Überdachung einzustecken. Anschließend ist das M4P1-Profil (57) hinzuzufügen und das Profil ist mit dem nach oben montierten Wagen mit dem M4P4-Profil (50) mit Hilfe der Schrauben von der Packung 1 zu verbinden.

4

PL: M4P3 (51) łączymy z M4P1 (57) za pomocą śrub nr 1 po obu stronach modułu. Wsuwamy następne części poliwęglanu. Profil M4P3 (51) nitujemy z profilem 53 nitem z opakowania 20.
ENG: We connect M4P3 (51) with M4P1 (57) with the use of screws no.1 on both sides of the module. We insert the next parts of polycarbonate. We rivet M4P3 (51) profile with the profile no. 53 using a rivet from package 20.
SE: M4P3 (51) ansluts till M4P1 (57) med skruvarna från paket 1 på båda sidor av modulen. Sätt i den andra delen av polykarbonatet. M4P3 (51)-profilen nitas med 53-profilen med en nit från 20-paketet.

5

PL: Cały moduł zamykamy profilem M4P4 (52) łącząc go z M4P1 (57) wkrętami z opakowania 1 po obu stronach. Uszczelniamy cały moduł uszczelkami nr 32 po zewnętrznej stronie.
ENG: We close the entire module with M4P4 (52) profile connecting it with M4P1 (57) using bolts from package 1 on both sides. We seal the entire module with seals no. 32 on the outside.
DE: Der ganze Modul ist mit dem M4P4-Profil (52) abzuschließen, der mit dem M4P1-Teil (57) mit Hilfe der Schrauben von der Packung 1 an den beiden Seiten zu verbinden ist. Der ganze Modul ist mit den Dichtungen Nr. 32 an der Innenseite abzudichten.

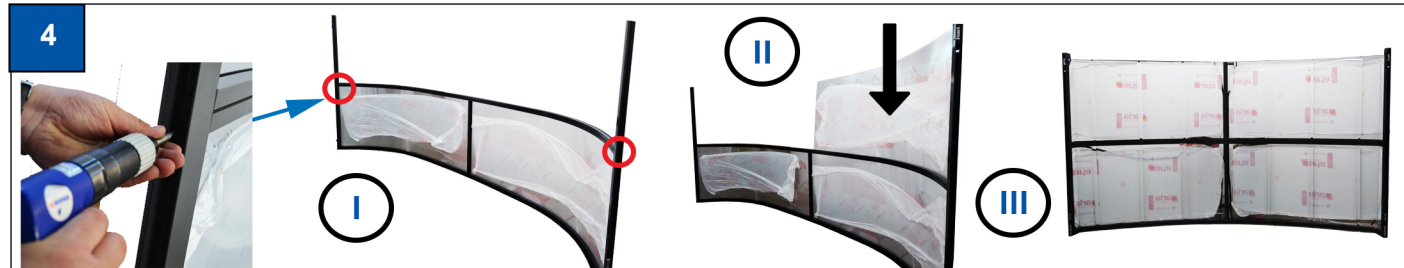
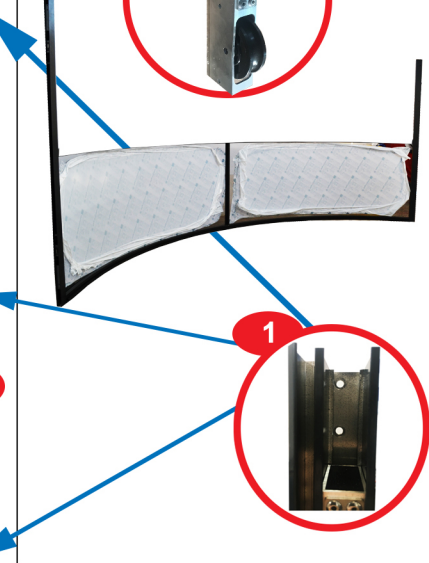
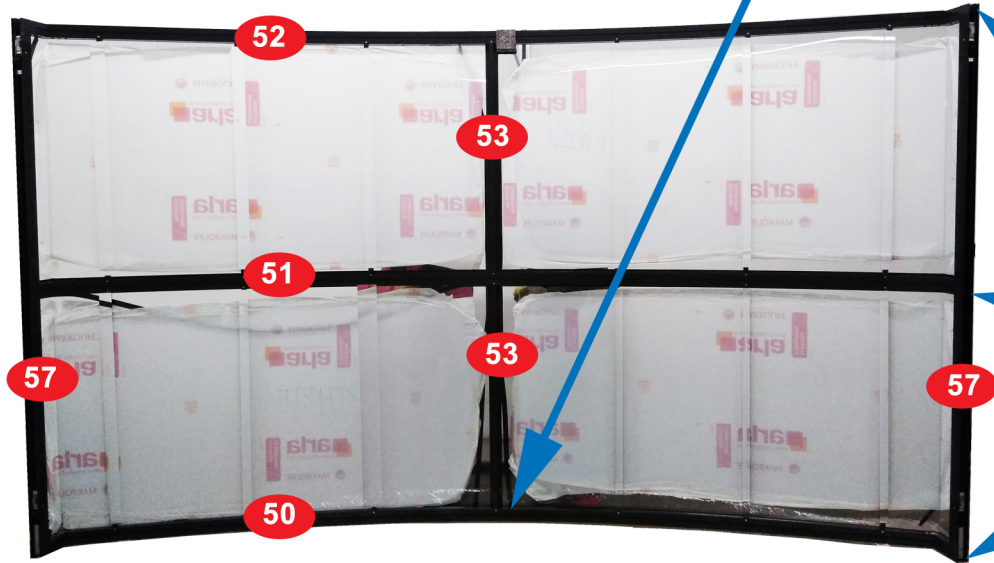
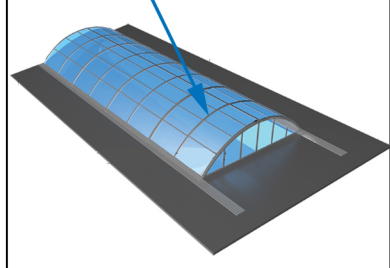
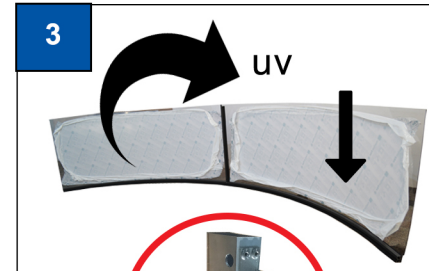
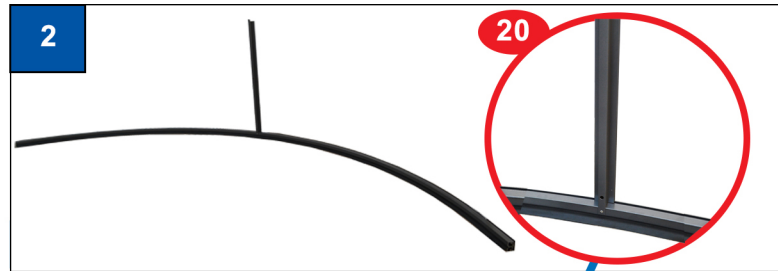
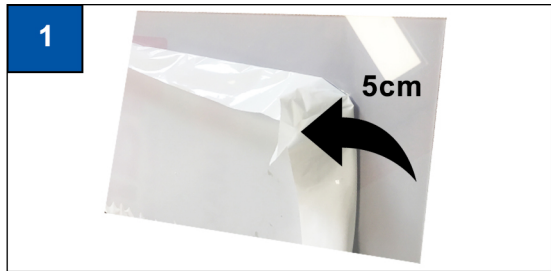



MONTAŻ MODUŁU 4 / INSTALLATION OF MODULE 4 / MONTAGE DES MODULS 4

6

PL: Dwanaście łączników 61 montujemy za pomocą nitów z opakowania 20 z profilami 52,51,50.
ENG: We mount twelve connectors 61 with the use of rivets from package 20 with profiles 52,51,50.
SE: Fäst de tolv kopplingarna 61 med hjälp av nitar i paket 20 med profilerna 52,51,50..

7

PL: Hamulce 29 przykręcamy śrubą imbusową nr 30 do wózków 65.
ENG: We screw in the brakes 29 with the use of six-lobe screw no. 30 to the carts 65.
SE: Skruva fast bromsarna 29 på boggierna 65 med insexskruvarna 30.

8

PL: Złożony wózek z hamulcem wsuwamy od dołu w profil 57 po prawej i lewej stronie zadaszania, następnie przykręcamy blachowkrętami nr 2.
ENG: We insert the folded cartes with the brakes into profiles 57 on the left and right side of roofing from the bottom and we screw it with sheet metal screws no. 2.
SE: Sätt in den monterade vagnen med broms underifrån i profil 57 på takets högra och vänstra sida och skruva fast den med plåtskruvar nr 2.

9

PL: Wkładamy zaślepki w odpowiednie miejsca: od dołu - zaślepki 5 lub 6, od góry - zaślepki 7 lub 8.
ENG: We insert blind plugs in proper places: from the bottom – blind plug 5 or 6, from the top - blind plugs 7 or 8.
SE: Sätt in kapslingarna på rätt plats: kapslingarna 5 eller 6 underifrån, kapslingarna 7 eller 8 ovanifrån.

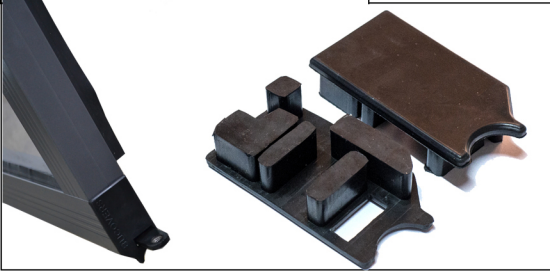
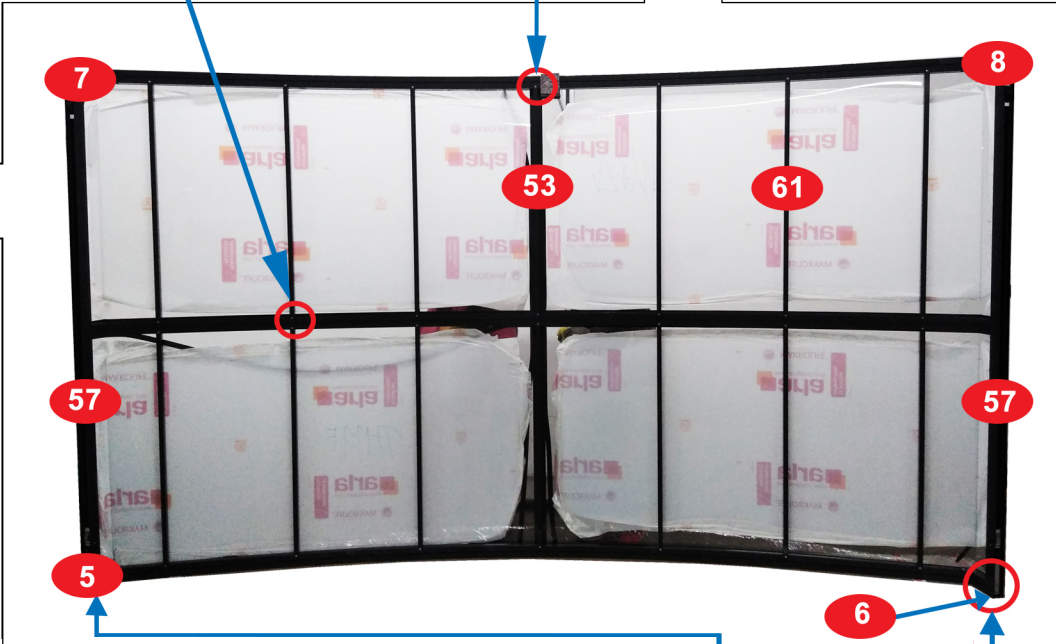
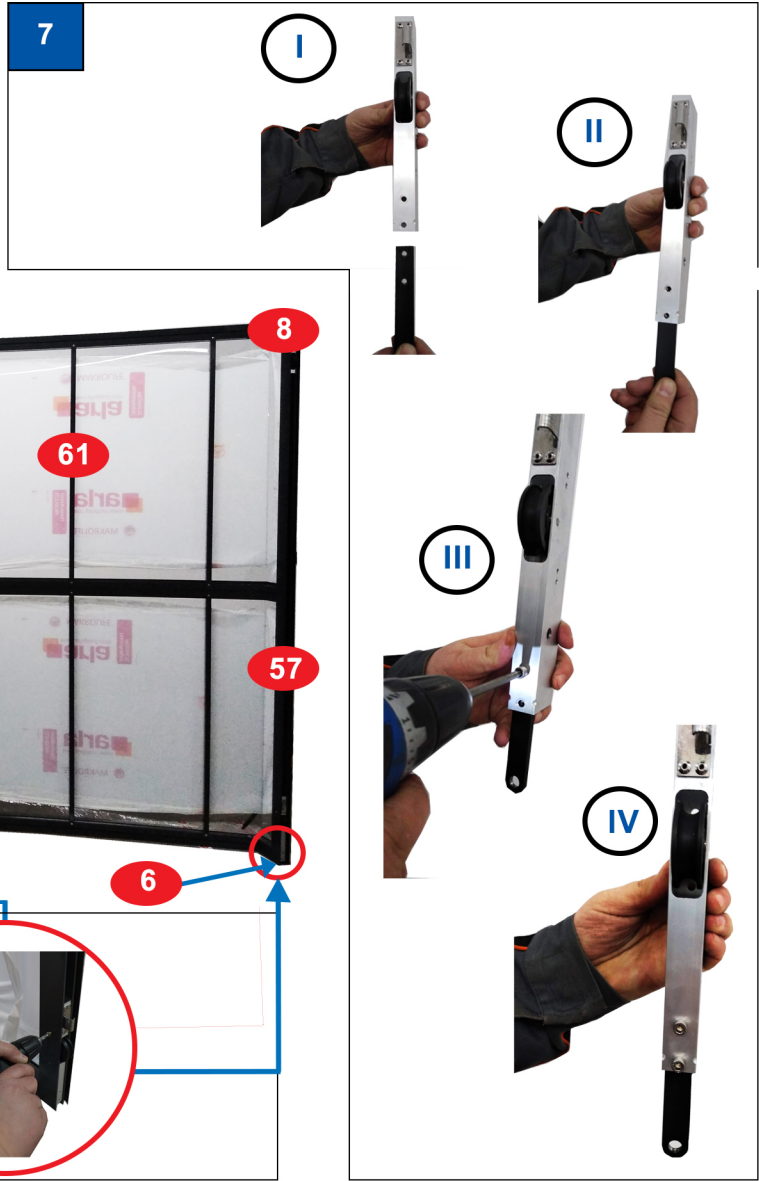
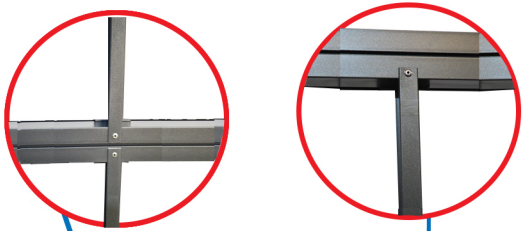

NARZĘDZIA - MODUŁ 5 / TOOLS - MODULE 5 / VERKTYG - MODUL 5

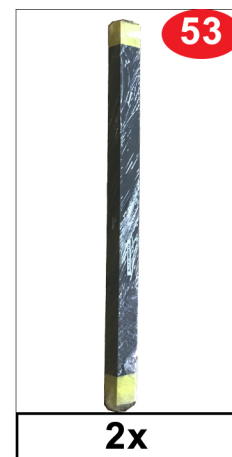
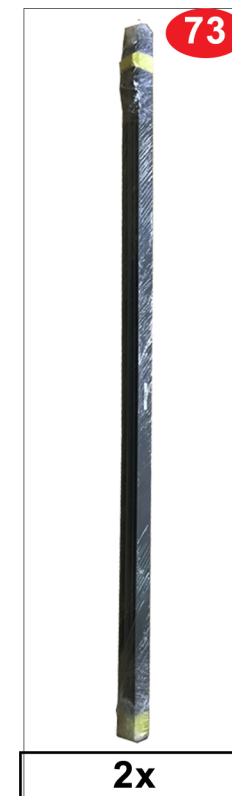





MONTAŻ MODUŁU 5 / INSTALLATION OF MODULE 5 / MONTERING AV MODUL 5

1

PL: Odklejamy 5 cm od każdego brzegu poliwęglanu.
ENG: We have to peel off 5 cm from every edge of polycarbonate.
SE: Avlägsna 5 cm från varje kant av polykarbonat

2

PL: Profil M5P4 (70) nitujemy z profilem 53 nitem z opakowania 20.
ENG: We rivet M5P4 (70) profile with the profile no. 53 using a rivet from package 20.
SE: M5P4 (70)-profilen nitas med 53-profilen med en nit från 20-paketet.

3

PL: W profil M5P4 (70) wkładamy poliwęglan napisami UV po zewnętrznej stronie zadaszenia. Następnie dokładamy i dokręcamy profil M5P1 (73) z zamontowanym wózkem do góry z profilem M5P4 (70) wkrętami z opakowania 1.
ENG: Into M5P4 (70) profile we insert polycarbonate with UV inscription on the exterior side of roofing. Afterwards we add and screw in M5P1 (73) profile with the cart mounted to the top with M5P4 (70) profile with bolts from package 1.
SE: Sätt in polykarbonat i M5P4-profilen (70) med UV-texten på ytersidan av taket. Lägg sedan till och dra åt profil M5P1 (73) med monterad vagn till profil M5P4 (70) med skruvar från förpackning 1

4

PL: M5P3 (71) łączymy z M5P1 (73) za pomocą śrub nr 1 po obu stronach modułu. Wsuwamy trzecią część poliwęglanu TYLKO po przeciwnej stronie drzwi. Profil M5P3 (71) nitujemy z profilem 53 nitem z opakowania 20.
ENG: We connect M5P3 (71) with M5P1 (73) with the use of screws no.1 on both sides of the module. We insert the third part of polycarbonate ONLY on the opposite side of the door. We rivet M5P3 (71) profile with the profile no. 53 using a rivet from package 20.
SE: M5P3 (71) ansluts till M5P1 (73) med skruvarna från paket 1 på båda sidor av modulen. Sätt in den tredje delen av polykarbonat endast på den motsatta sidan av dörren. M5P3 (71)-profilen nitas med 53-profilen med en nit från 20-paketet.

5

PL: Cały moduł zamykamy profilem M5P4 (72) łącząc go z M5P1 (73) wkrętami z opakowania 1 po obu stronach. Uszczelniamy cały moduł uszczelkami nr 32 po zewnętrznej stronie.
ENG: We close the entire module with M5P4 (72) profile connecting it with M5P1 (73) using bolts from package 1 on both sides. We seal the entire module with seals no. 32 on the outside.
SE: Stäng hela modulen med profilen M5P4 (72) och anslut den till M5P1 (73) med hjälp av skruvarna från paket 1 på båda sidor. Vi tätar hela modulen med packningar nr 32 på utsidan.

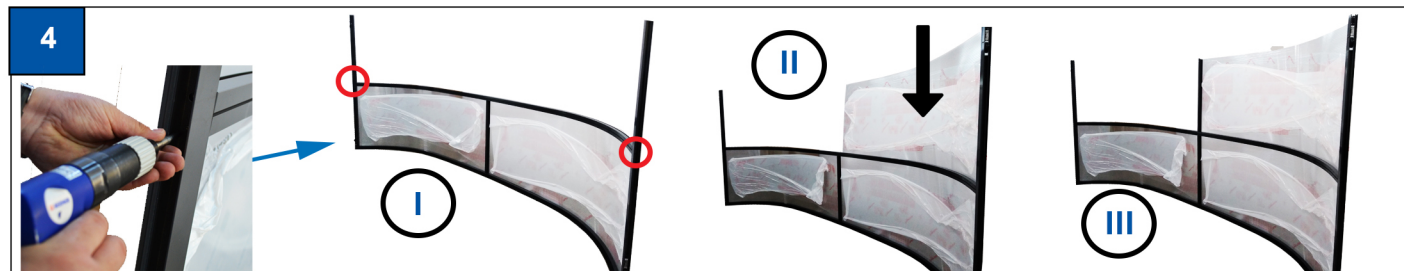
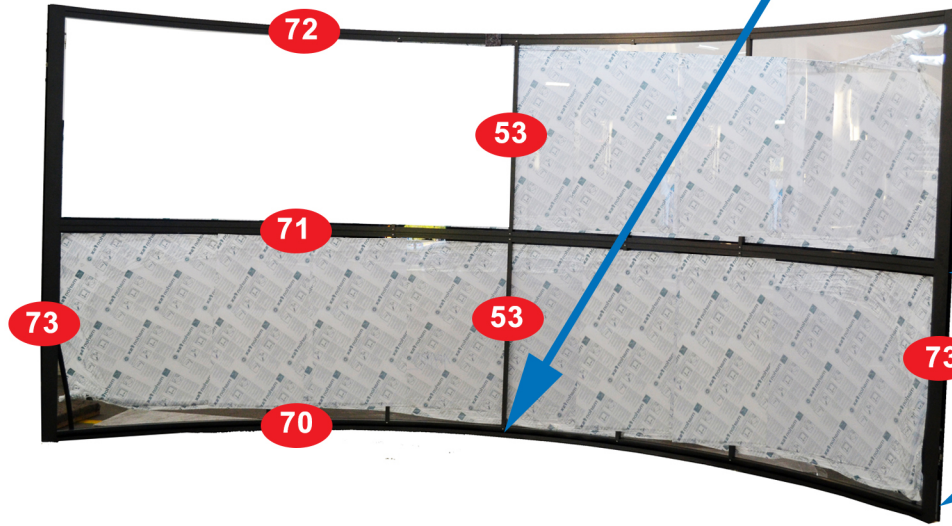
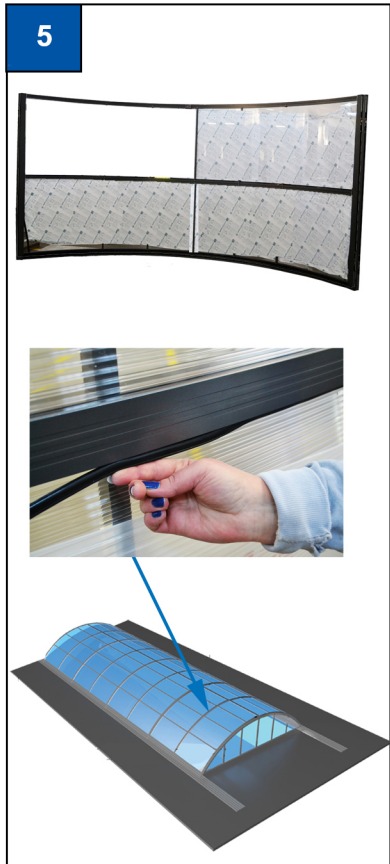
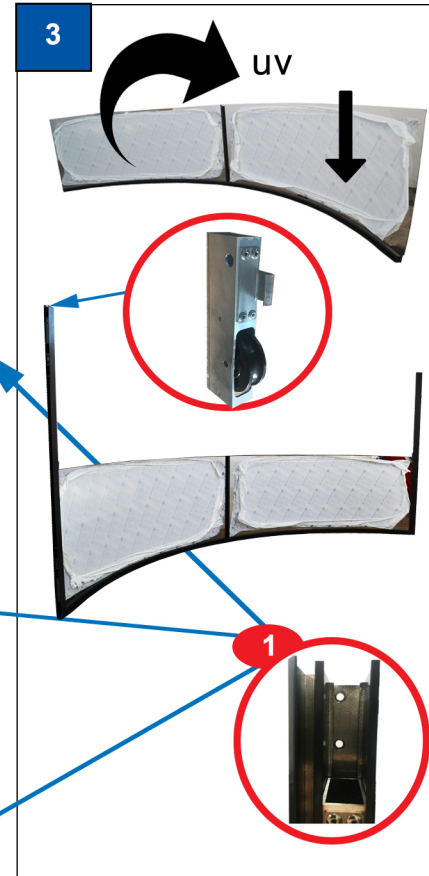
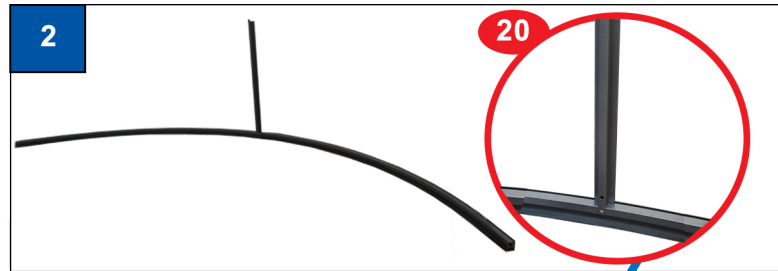
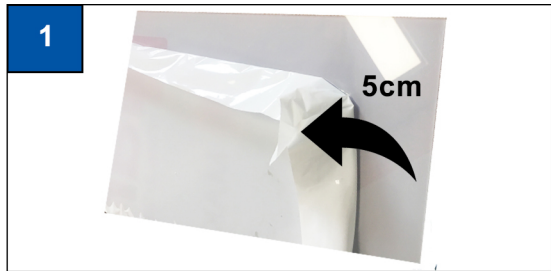



MONTAŻ MODUŁU 5 / INSTALLATION OF MODULE 5 / MONTAGE DES MODULS 5

6

PL: Dziewięć łączników **74** montujemy za pomocą nitów z opakowania **20** z profilami **72,71,70**.
ENG: We fasten nine connectors no. **74** with the use of rivets from package **20** using profiles **72,71,70**.
SE: Fäst de sex kopplingarna **74** med hjälp av nitar i paket **20** med profilerna **72,71,70**.

7

PL: Hamulce **29** przykręcamy śrubą imbusową nr **30** do wózków **65**.
ENG: We screw in the brakes **29** with the use of six-lobe screw no. **30** to the carts **65**.
SE: Skruva fast bromsarna **29** på boggierna **65** med insexskruvarna **30**.

8

PL: Złożony wózek z hamulcem wsuwamy od dołu w profil **73** po prawej i lewej stronie zadaszenia, następnie przykręcamy blachowkrętami nr **2**.
ENG: We insert the folded cartes with the brakes into profiles **73** on the left and right side of roofing from the bottom and we screw it with sheet metal screws no. **2**.
SE: Sätt in den monterade vagnen med broms underifrån i profil **73** på takets högra och vänstra sida och skruva fast den med plåtskruvar nr **2**.

9

PL: Wkładamy zaślepki w odpowiednie miejsca: od dołu - zaślepki **5** lub **6**, od góry - zaślepki **7** lub **8**.
ENG: We insert blind plugs in proper places: from the bottom – blind plug **5** or **6**, from the top - blind plugs **7** or **8**.
SE: Sätt in kapslingarna på rätt plats: kapslingarna **5** eller **6** underifrån, kapslingarna **7** eller **8** ovanifrån.

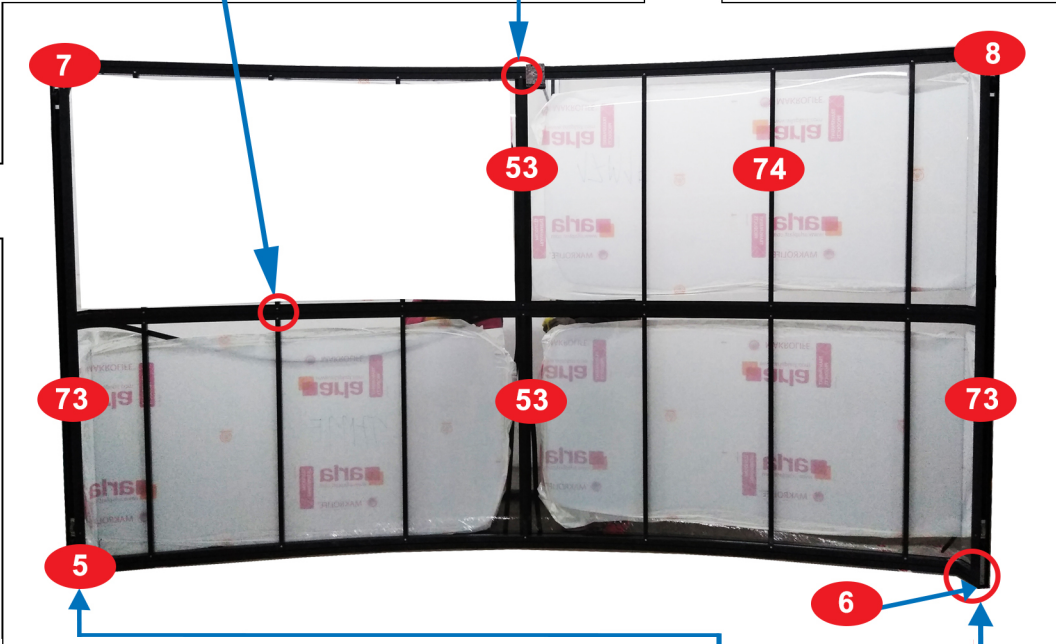
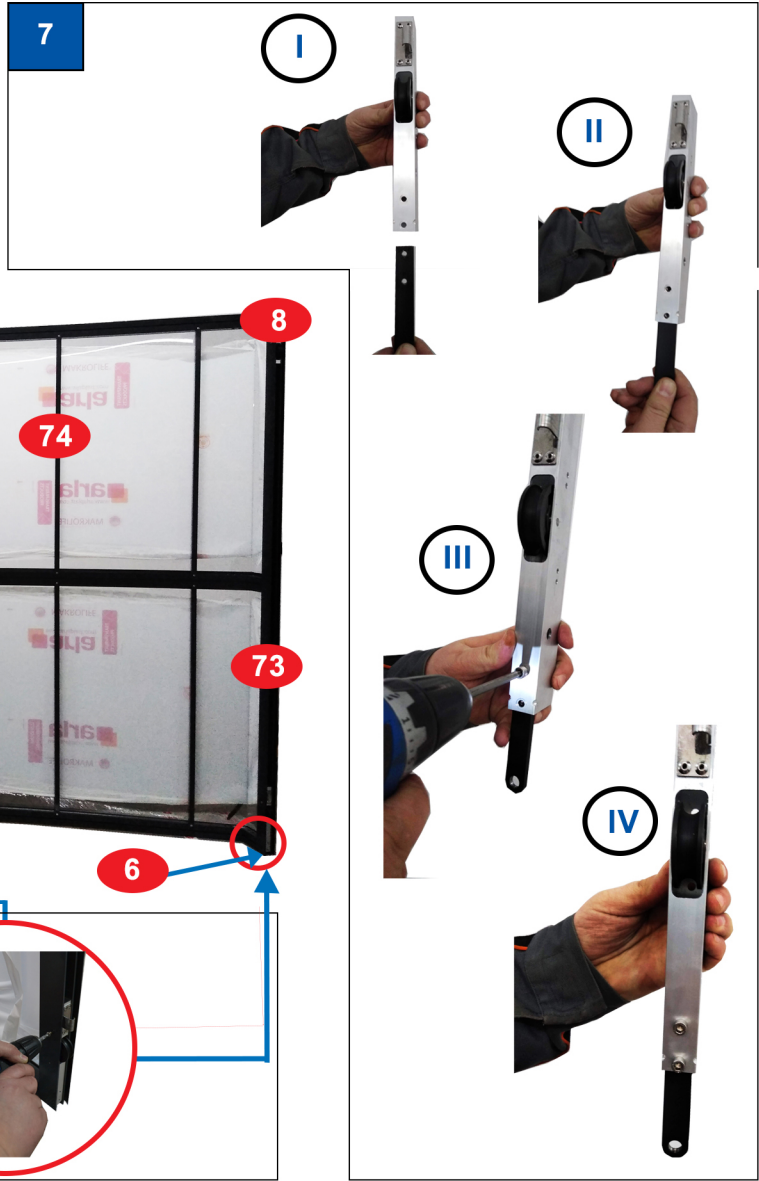
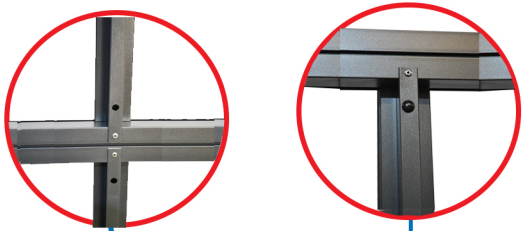



MONTAŻ MODUŁU 5 / INSTALLATION OF MODULE 5 / MONTERING AV MODUL 5

MONTAŻ SZYN OD DRZWI - DÓŁ / INSTALLATION OF RAILS FROM DOORS - BOTTOM / MONTERING AV DÖRRSKENOR – NEDRE DEL

10

PL: Szynę do drzwi nr 63 z otworami przywiercamy śrubą z opakowania 3 przez gotowe otwory do profilu 73.

ENG: We screw the rail to the door no. 63 with openings using a bolt no. 3 through the premade holes for the profile no. 73.

SE: Fäst dörrskenan nr 63 med hål med skruv från förpackning 3 genom de förborrade hålen i profil 73.

11

PL: Zamykamy otwory zaślepką nr 13. Wstawiamy uszczelkę progową nr 24 w sposób przedstawiony na rysunku.

ENG: We close the openings with a blind plug no. 13. We insert the threshold seal no. 24 as shown in the picture.

SE: Stäng hålen med hölje nr 13. Sätt in tröskeltätningen nr 24 enligt ritningen.

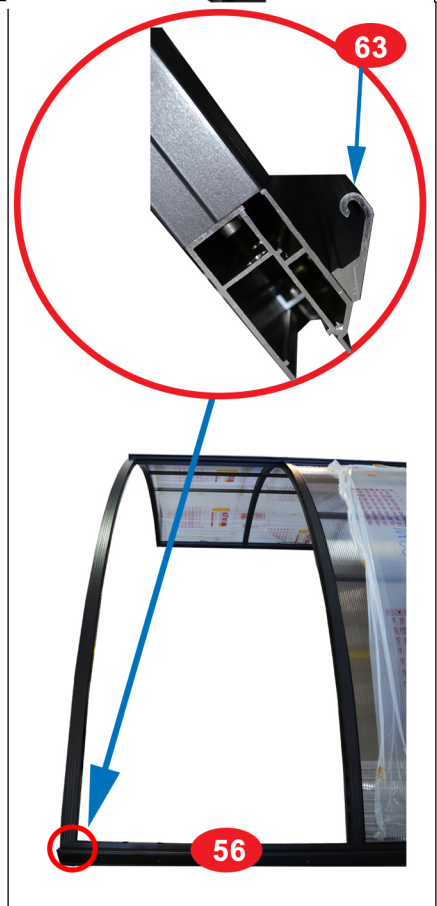
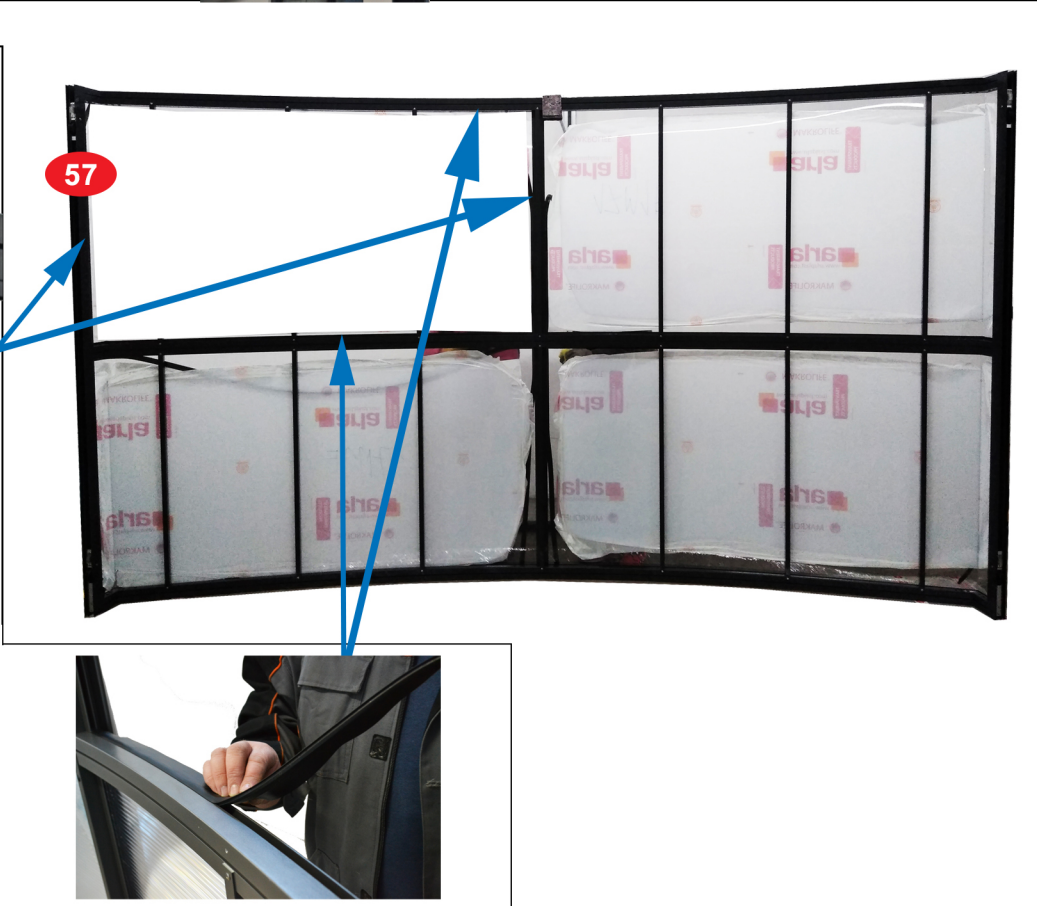
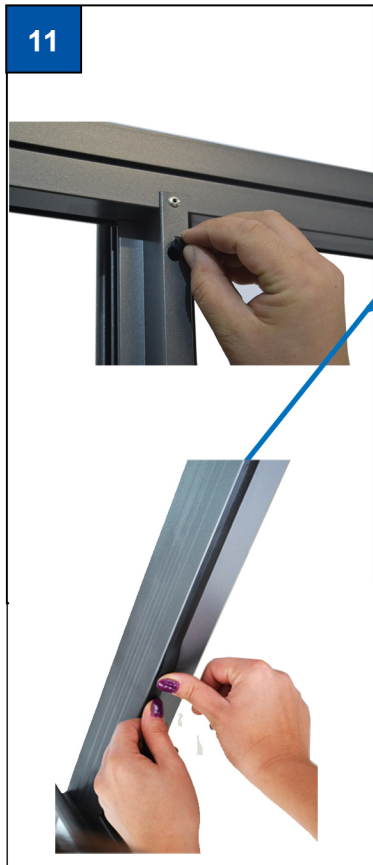
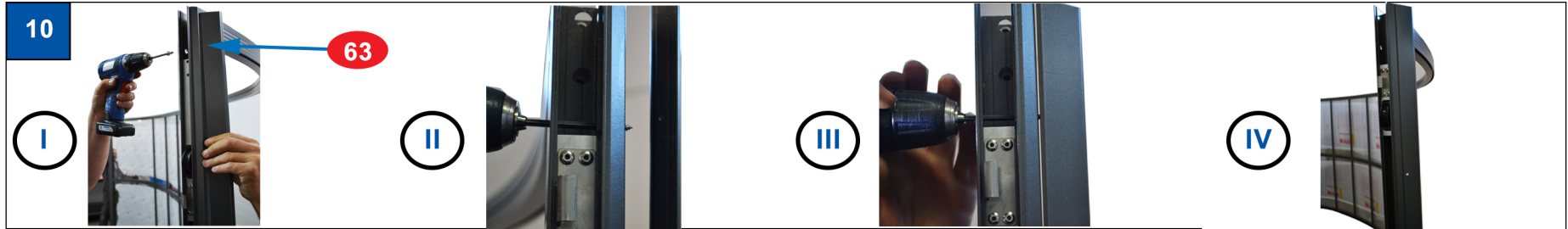



MONTAŻ MODUŁU 5 / INSTALLATION OF MODULE 5 / MONTAGE DES MODULS 5

MONTAŻ SZYN OD DRZWI - GÓRA / INSTALLATION OF RAILS FROM DOORS - TOP / MONTERING AV DÖRRSKENOR – ÖVRE DEL

12

PL: Szynę do drzwi nr 63 bez otworów na odpływ wody przywiercamy śrubą z opakowania 10 z profilem 53.

ENG: We screw the rail to the door no.63 without openings for outflow of water using a bolt from package 10 with the profile no.53.

SE: Fäst dörrskenan 63 utan hål för vattenavrinning med skruven från förpackning 10 till profil 53.

13

PL: Zamykamy otwory zaślepką nr 13.

ENG: We close the openings with a blind plug no. 13.

SE: Stäng hålen med skydd nr 13.





NARZĘDZIA - DRZWI / TOOLS - DOORS / WERKZEUGE - TÜR

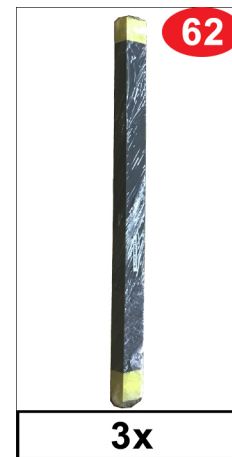
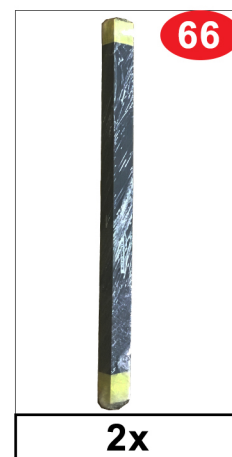
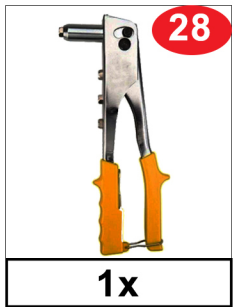
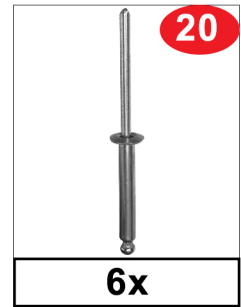
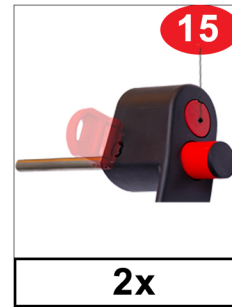



MONTAŻ DRZWI / INSTALLATION OF DOORS / MONTERING AV DÖRRAR

1

PL: Odklejamy 5 cm od każdego brzegu poliwęglanu.
ENG: We have to peel off 5 cm from every edge of polycarbonate.
SE: Avlägsna 5 cm från varje kant av polykarbonat.

2

PL: W łuk 67 wkładamy poliwęglan napisami UV po zewnętrznej stronie zadaszenia. Profil 67 łączymy z profilami 66 (od góry profil z gumą) i dokręcamy wkrętami z opakowania 1 po dwóch stronach.
ENG: Into the arch no. 67 we insert polycarbonate with UV inscription on the exterior side of roofing. Afterwards we connect the profile no.67 with profiles no. 66 (from the top, the profile with rubber) and we screw it in with bolts from package 1 on both sides.
SE: Sätt in polykarbonat i båge 67 med UV-texten på ytersidan av taket. Koppla profil 67 till profil 66 (ovanifrån profilen med gummi) och dra åt med skruvar från förpackning 1 på båda sidor.

3

PL: Całość zamykamy drugim profilem 67 i przykręcamy wkrętami z opakowania 1.
ENG: We close the entire setup with the second profile no. 67 and we screw it in with bolts from package 1.
SE: Stäng igen helheten med den andra profilen 67 och fäst den med skruvarna från förpackning 1.

4

PL: Łącznik 62 mocujemy w przygotowanych otworach za pomocą nitów nr 20. Zakładamy zaślepki nr 7 i 8.
ENG: We fasten the connector no. 62 in premade openings with the use of rivets no. 20. We place the blind plugs no. 7 and 8.
SE: Fäst kopplingen 62 i de förberedda hålen med hjälp av nitar nr 20. Sätt på skydd nr 7 och 8.

5

PL: Przykręcamy klamkę nr 14 wkrętami z opakowania 1 w gotowe otwory w profilu 67 po wybranej stronie. Zakładamy zaślepki nr 15 oraz 31. Uszczelniamy drzwi po zewnętrznej stronie uszczelkami nr 32.
ENG: We screw in the door knob no.14 using bolts from package 1 into premade openings in the profile no. 67 on the selected side. We place the blind plugs no.15 and 31. We seal the door on the exterior side with seals no. 32.
SE: Skruva fast handtag nr 14 med hjälp av skruvarna från förpackning 1 i de förberedda hålen i profil 67 på vald sida. Sätt på skydd nr 15 och 31.

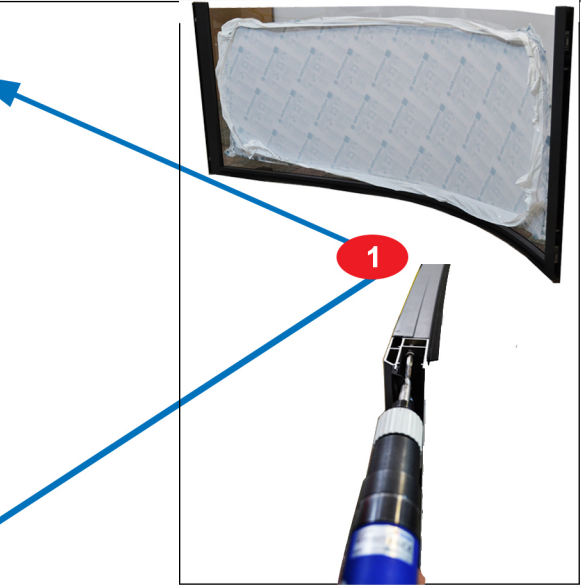
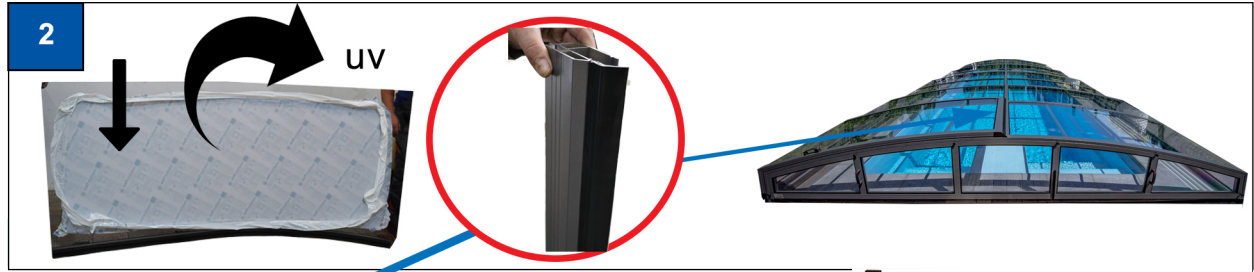
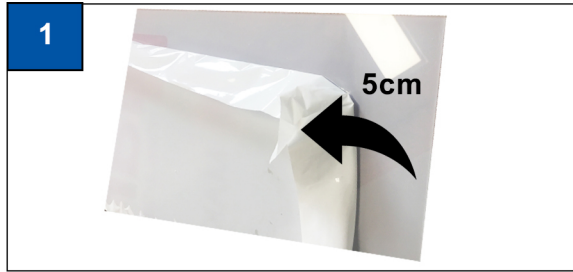



NARZĘDZIA - MONTAŻ / TOOLS - INSTALLATION / VERKTYG - INSTALLATION

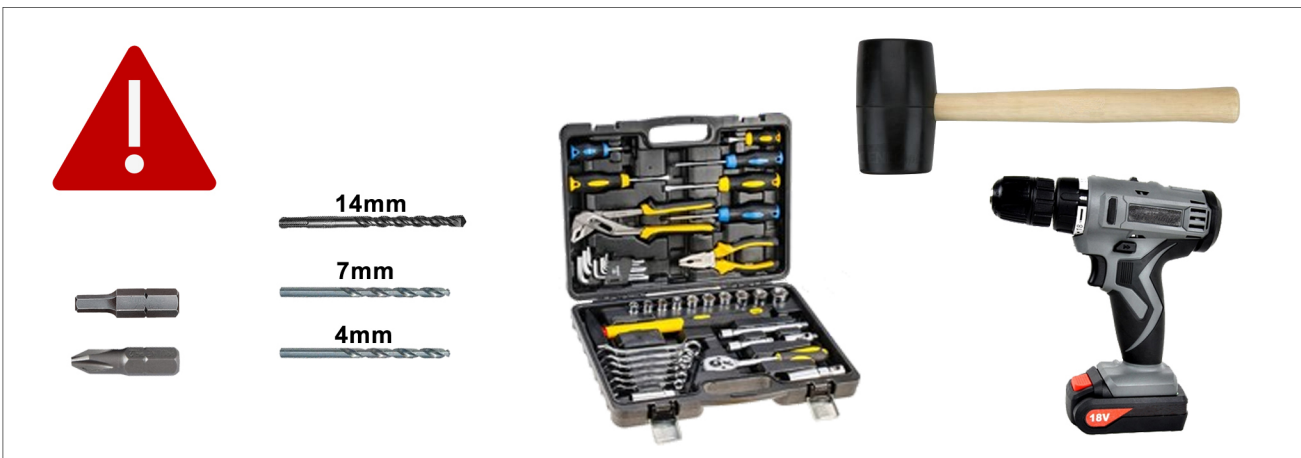
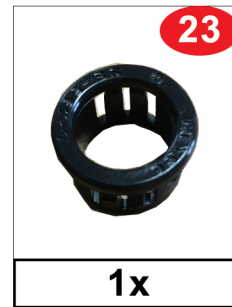



MONTAŻ / INSTALLATION

1

PL: Przygotowane moduły z hamulcem nr 29 wsuwamy na szyny w sposób przedstawiony na rysunku. Zaczynamy od modułu 1, następny moduł 2, 3, 4, 5.

ENG: We insert the prepared modules with the brake no. 29 to the rail in the way shown on the illustration. We start from module 1, followed by module 2, 3, 4, 5.

SE: Skjut de förberedda bromsmodulerna nr 29 på skenorna enligt bild. Börja med modul 1, därefter modul 2, 3, 4, 5.

2

PL: Montujemy odbojniki nr 11 na końcu i początku szyny za pomocą śrub z opakowania 12. Z każdej strony po 10 sztuk odbojników.

ENG: We mount the bump stops no. 11 in the end and beginning of the rail with the use of bolts from package 12. On each side there are 10 pieces of bump stops.

SE: Montera stötskydd nr 11 i slutet och början av skenan med hjälp av skruvarna från förpackning 12. Det ska vara 8 stötskydd på varje sida.

3

PL: Na końcach szyn wkładamy zaślepki z opakowania 22 i 26.

ENG: On both ends of rails we insert blind plugs from packages 22 and 26.

SE: Sätt in ändskydden från förpackningarna 22 och 26 i skenans båda änden.

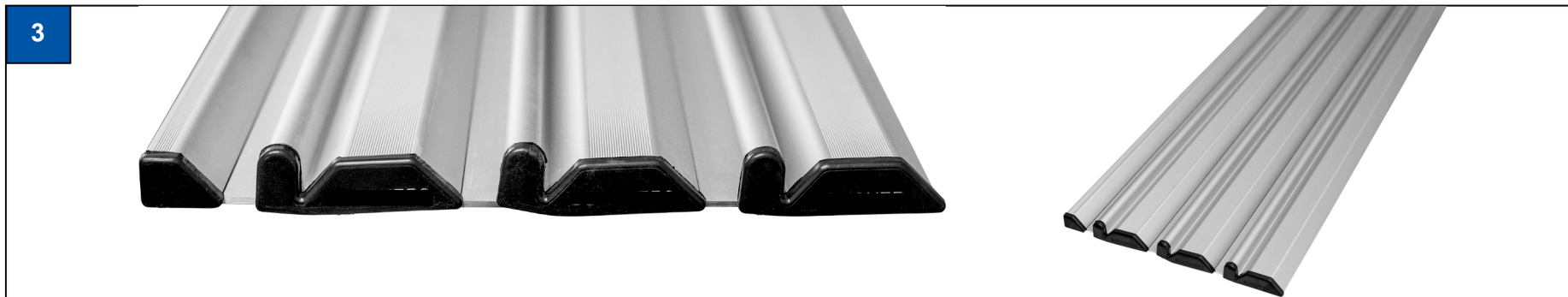
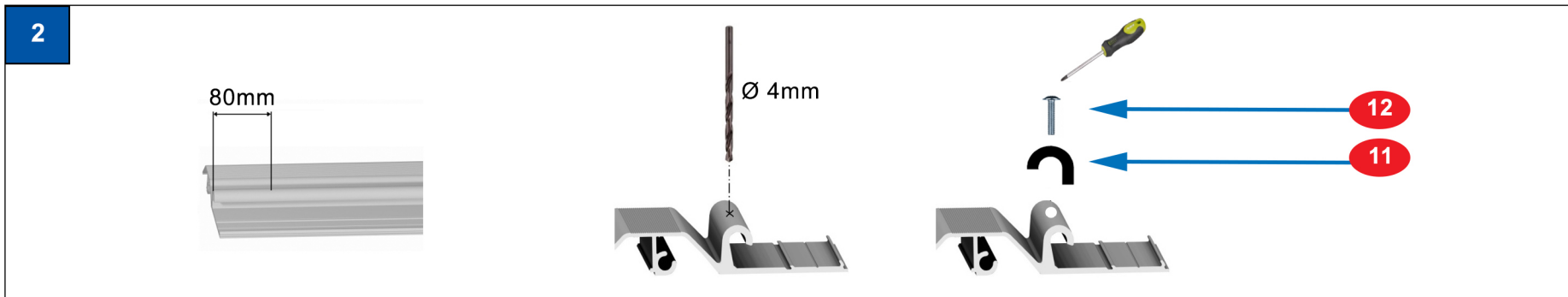
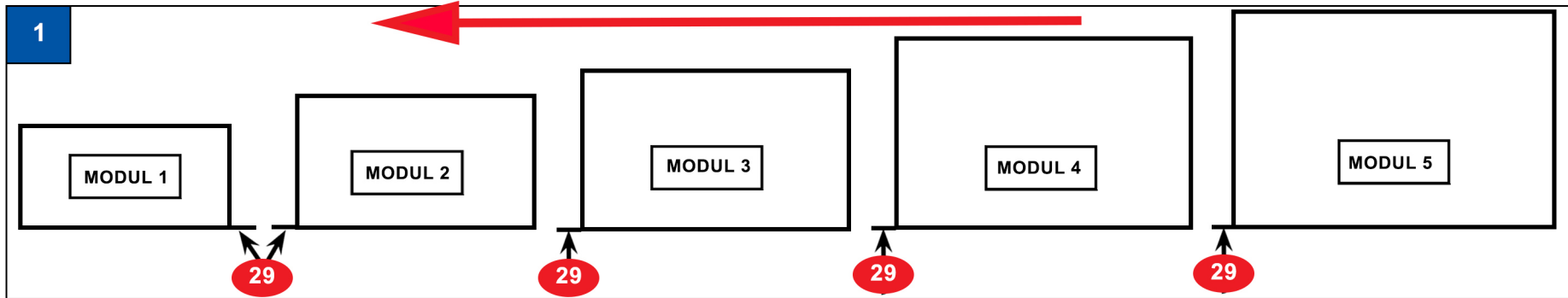



MONTAŻ / INSTALLATION

4

PL: W przygotowane szyny nr 63 w module 5 wsuwamy drzwi gumowym fartuchem do góry.
ENG: We insert the door into the prepared rails no. 63 in module 5 with the rubber gasket up.
SE: Sätt in dörren med gummiskyddet uppåt i de förberedda skenorna nr 63 i modul 5.

5

PL: W górną i dolną szynę wsuwamy z każdej strony poliamidowe blokady nr 33 i przykręcamy je śrubą nr 9 w miejscu, gdzie są nawiercony otworów. Zapobiegają one wysunięciu się drzwi z szyn.
ENG: Insert polyamide locks No. 33 into the upper and lower rails on each side and screw them with screw No. 9 in the place where holes are drilled. They prevent the door from sliding off the rails.
SE: Sätt in polyamidstopparna nr 33 från varje sida i den övre och nedre skenan och fäst dem med skruv nr 9 i de förborrade hålen. De förhindrar att dörren glider ut ur skenorna.

6

PL: Po ustawieniu drzwi zaznaczamy miejsce na otwór Ø14mm do trzpienia klamki. Po wywierceniu wkładamy przepust nr 23 w otwór. Zakładamy zaślepki nr 25 w otwory szyn.
ENG: After mounting the door, we mark the place for the opening Ø14mm to the door knob shank. After drilling out, we insert the culvert no. 23 into the opening. We insert the blind plugs no. 25 into the rail openings.
SE: Efter att ha placerat dörren markerar du platsen för 14 mm-hålet för handtagsbulten. Efter borring sätts bussning nr 23 i hålet. Sätt skydd nr 25 på hålen i skenorna.

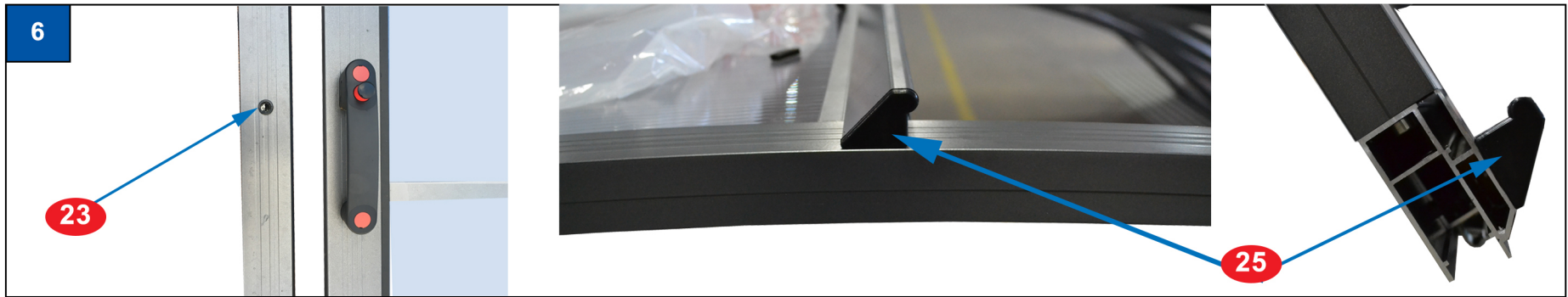
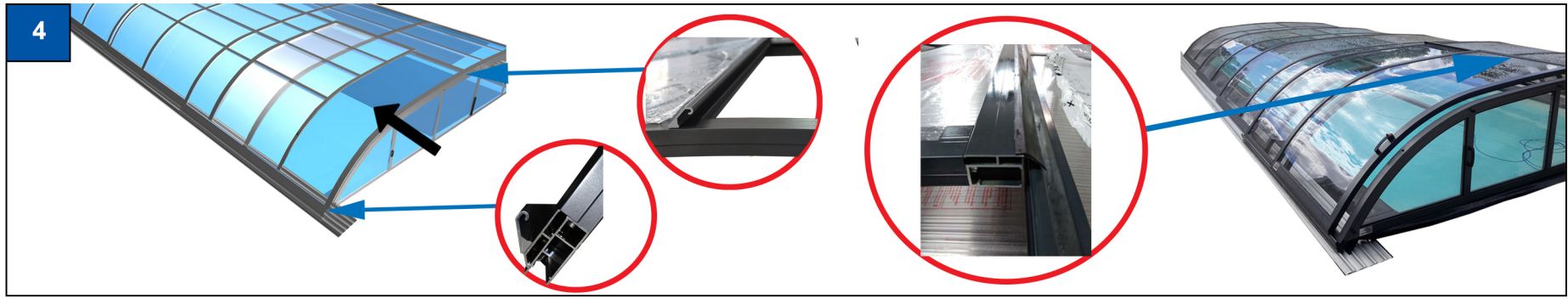



MONTAŻ / INSTALLATION

7

PL: Ustawiamy moduły w pozycji zamkniętej. W otwór hamulca przy każdym module wkładamy trzpień hamulca nr 4 aby wyznaczyć właściwe miejsce do przewiercenia otworów w szynie.

ENG: We place modules in the closed position. We insert the brake ratchet no. 4 in the brake opening at every module in order to mark a proper place for drilling openings in the rail.

SE: Placera modulen i stängt läge. Sätt in bromsstift nr 4 i bromshålet på varje modul för att markera rätt position för hålbörning i skenan.

8

PL: Od dołu przykręcamy nakrętkę kontrolującą.

ENG: We screw in the control washer from the bottom.

SE: Skruva på kontrollmuttern underifrån.

9

PL: Wiercimy w szynie otwory Ø7mm do hamulców nr 4. Tak zamontowany hamulec zabezpiecza przed zsunięciem modułu z szyn.

ENG: We drill openings Ø7mm in the rail to the brakes no. 4. The brake mounted in this way protects against falling off the module from rails.

SE: Borra 7 mm hål i skenan för bromsskaft nr 4. Bromsen som monteras på detta sätt förhindrar att modulen glider av skenan.

7

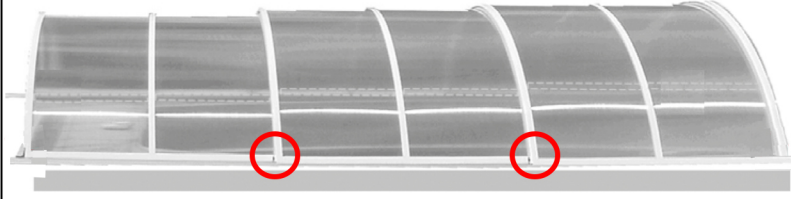

8



9





MONTAŻ / INSTALLATION

10

PL: Ścianę mniejszą dokładnie przykładamy i przykręcamy do modułu 1 za pomocą wkrętów z opakowania 21 do nawierconych już otworów.

ENG: We carefully attach the smaller wall and screw to the module no. 1 with the use of bolts from package 21 to the pre-drilled openings.

SE: Placera försiktigt den nedre väggen och skruva fast den till modul 1 med hjälp av skruvarna från paket 21 i de förborrade hålen.

11

PL: Na przymocowany wkręt nakładamy zaślepkę z opakowania 27.

ENG: We place a blind plug from package 27 to the fastened bolt.

SE: Placera locket från förpackning 27 på den fastskruvade skruven.

12

PL: W taki sam sposób montujemy większą ścianę do modułu 5.

ENG: In the same way we mount the larger wall to the module no. 5.

SE: Fäst den övre väggen på modul 5 på samma sätt.

13

PL: Opuszczamy skobel zasuwy przeciwwiatrowej, która znajduje się na module 1 i zaznaczamy miejsce odwiertu.

ENG: We leave the wind block, which is on module 1, and mark the place of the borehole.

SE: Vi lämnar vindblocket, som finns på modul 1, och markerar platsen för borrhålet.

10



11

I



II



27

13



14 mm

**Jak korzystać z zadaszenia i uniknąć uszkodzeń:**

Nie pozostawiać ciężkich przedmiotów na szynach.

Nie uderzać w powłokę lakierowaną profili aluminiowych i w płyty z poliwęglanu.

Unikać zalegania drobnych przedmiotów w zagłębieniach szyn (kamieni, liści, żwiru, lodu).

Unikać zalegania na zadaszeniu grubych warstw śniegu i lodu - pokrywa śnieżna powyżej 10 cm grubości musi zostać usunięta.

Czyszczenie i konserwacja zadaszenia:

Stosować rekomendowane akcesoria czyszczące i środki czystości.

Nie używać szorstkich i ostrych akcesoriów. Zalecane są miękkie ściereczki (najlepiej z mikrofibry).

Nie używać do czyszczenia gorącej i wrzącej wody oraz nie myć w temperaturze poniżej 0 stopni Celsjusza.

Nie używać detergentów przeznaczonych do czyszczenia powierzchni szklanych.

Nie używać środków na bazie alkoholu, metanolu i wszelkich rozpuszczalników.

Zalecane jest używanie delikatnych mydeł lub płynów do naczyń (nie skoncentrowanych).

**Podstawowe zasady bezpieczeństwa:**

Należy używać zadaszenia zgodnie z jego przeznaczeniem.

Korzystanie przez dzieci wyłącznie pod nadzorem osoby dorosłej.

Nie przesuwaj modułów zadaszenia, gdy ktoś znajduje się na szynach.

Po zakończeniu korzystania z zadaszenia należy zawsze zabezpieczać wszystkie moduły, drzwi, przednią i tylną ścianę, tak aby zadaszenie było kompletne i bezpieczne.

Nie rozpalać ognia w bezpośrednim sąsiedztwie zadaszenia.

Zachować szczególną ostrożność podczas użytkowania mebli i akcesoriów basenowych, których ostre krawędzie mogą uszkodzić poliwęglan i profile.

Nie stosować przewodów elektrycznych i innych źródeł prądu w pobliżu aluminiowych elementów zadaszenia, ponieważ grozi to porażeniem prądem.

UWAGA !!!

Aluminium jest bardzo dobrym przewodnikiem prądu.

Przy wysokich temperaturach "daj basenowi oddychać" - zadaszenie należy rozsunąć i zapewnić cyrkulację powietrza.

**ZABRONIONE JEST WCHODZENIE NA ZADASZENIE**



How to use the pool enclosure and avoid damage:

Avoid leaving heavy objects on the rails.

Avoid striking the painted aluminum profiles and polycarbonate panels.

Avoid placing small objects in the cavities of the rails (stones, leaves, gravel, ice).

Remove thick layers of snow and ice (over 10cm) from the enclosure.

Cleaning and maintenance of the pool enclosure:

Use recommended cleaning products and accessories.

Do not use rough or sharp accessories. Soft cloths are recommended (preferably microfiber).

Do not use hot or boiling water to clean and do not wash under 0 degrees Celsius.

Do not use detergents for cleaning glass surfaces.

Do not use cleaning agents based on alcohol, methanol or any solvents.

It is recommended to use delicate soaps or dishwashing liquids (not concentrated).

INFORMATION



Basic safety rules :

The enclosure must only be used for the purposes for which it is intended, i.e. covering the pool.

Use by children only under the supervision of an adult.

Do not move the enclosure modules if someone is standing on the rails.

After use, always secure all modules, doors and the front and rear walls to make the enclosure safe and complete.

Do not light a fire near the enclosure.

Take special care when using pool furniture and accessories, which sharp edges can damage polycarbonate and profiles.

Do not use electric wires and other power sources near aluminum parts of the enclosure, as they may be cut.

WARNING!!!

Aluminum is a very good current conductor.

At high temperatures, "let the pool breathe" – the enclosure should be opened/ spread/apart and air circulated.



IT IS FORBIDDEN TO ENTER AND WALK ON THE ENCLOSURE



ANVÄNDNING AV POOLTAKET OCH UNDVIKANDE AV SKADOR:

Lämna inga tunga föremål på skenorna.

Slå inte mot den målade beläggningen på aluminiumprofilerna eller polykarbonatskivorna.

Undvik att placera små föremål i skenornas håligheter (stenar, löv, grus, is).

Förhindra tjocka lager av snö och is på taket – snölager som är tjockare än 10 cm måste avlägsnas

RENGÖRING OCH UNDERHÅLL AV POOLTAKET:

Använd rekommenderade rengöringstillbehör och rengöringsmedel.

Använd inte grova eller vassa tillbehör. Mjuka trasor (helst mikrofiber) rekommenderas.

Använd inte varmt eller kokande vatten för rengöring och tvätta inte vid temperaturer under 0 grader Celsius.

Använd inte rengöringsmedel som är avsedda för rengöring av glasytor.

Använd inte alkohol, metanol eller andra lösningsmedel.

Användning av mild tvål eller diskmedel (ej koncentrat) rekommenderas.

**GRUNDLÄGGANDE SÄKERHETSREGLER:**

Använd pooltaket i enlighet med dess ändamål.

Barnens användning av pooltaket endast under vuxnas överinseende.

Flytta inte pooltakets moduler när någon befinner sig på skenorna.

När du är klar användningen ska du alltid säkra alla moduler, dörrar, fram- och baksidor så att pooltaket är komplett och säkert.

Tänd inte eld i omedelbar närhet av pooltaket.

Var särskilt försiktig när du använder poolmöbler och tillbehör, vars vassa kanter kan skada polykarbonat och profiler.

Använd inte elkablar eller andra elektriska källor i närheten av pooltakets aluminiumkomponenter, eftersom detta kan orsaka en elektrisk stöt.

OBS!

Aluminium är en mycket god ledare för elektricitet.

Vid höga temperaturer – "låt poolen andas", dvs. dra isär pooltaket så att luftcirkulationen garanteras.

**DET ÄR FÖRBJUDET ATT KLÄTTRA PÅ POOLTAKET.**

S 5M 4200